



Cast iron performance

WOODBURNING • MULTI-FUEL • GAS • ELECTRIC



United Kingdom & Republic of Ireland
distributors for Dovre:

Stovax Limited
Falcon Road, Sowton Industrial Estate,
Exeter EX2 7LF
Trade Sales tel: 01392 474000
Other depts tel: 01392 474011
Fax: 01392 219932
E-mail: dovre@stovax.com
Internet: www.dovre.co.uk

Your local Dovre retailer:

£2.00

DOVRE1108

© All material copyright Stovax Ltd 2008

Stovax gratefully acknowledges the assistance of the following companies with photographic settings:

Apple Conservatories - www.appleconservatories.com • Ashore - 01392 477763 • Debenhams - www.debenhams.com • Eclectique - www.eclectique.co.uk
Fagins Antiques - www.faginsantiques.com • Farmington Stone Fireplaces - www.farmington.co.uk • Furniture Village - www.furniturevillage.co.uk
Habitat - www.habitat.com • House of Fraser - www.houseoffraser.co.uk • Laura Ashley - www.lauraashley.com • Merchant House Antiques - www.merchanthouseantiques.co.uk
Orange Tree - www.theorangetree.co.uk • Original Style - www.originalstyle.com • St Bridgets Nurseries - www.stbridgetsnurseries.co.uk



Traditional Stoves

04

CONTENTS

Traditional stoves

| | |
|--------------------|---------|
| 250 stove | 4 - 5 |
| 280 gas stove | 6 - 7 |
| 280 electric stove | 8 - 9 |
| 425 stove | 10 - 11 |
| 425 gas stove | 12 - 13 |
| 425 electric stove | 14 - 15 |
| 500 stove | 16 - 17 |
| 500 electric stove | 18 - 19 |
| 555 stove | 20 - 21 |
| 640 stove | 22 - 23 |
| 700 stove | 24 - 25 |
| 760 stove | 26 - 27 |

Astroline contemporary stoves

| | |
|---------------------|---------|
| Astroline 1 stove | 28 - 29 |
| Astroline 2 stove | 30 - 31 |
| Astroline 3 stove | 32 - 33 |
| Astroline 4 stove | 34 - 35 |
| Astroline 350 stove | 36 - 37 |
| Astroline 360 stove | 38 - 39 |

Contemporary cassette fireplaces

| | |
|----------------------------|---------|
| 2510 double-sided cassette | 40 - 41 |
| 2520 cassette | 42 - 43 |

Traditional insert and canopied fireplaces

| | |
|--------------------------|---------|
| 1800 fireplace | 44 - 45 |
| 2000 fireplace | 46 - 47 |
| 2300 fireplace | 48 - 49 |
| 2400 fireplace | 50 - 51 |
| 2700 fireplace | 52 - 53 |
| 2900 fireplace | 54 - 55 |
| 1800 gas fireplace | 56 - 57 |
| 2700 gas fireplace | 58 - 59 |
| Canopies and accessories | 60 - 61 |

| | |
|------------------------|---------|
| Flue Pipe & Stove Care | 62 - 63 |
| Dimensions | 64 - 67 |

Contemporary Cassette Fireplaces

40



Dovre takes its company name from a range of Norwegian mountains, and has more than 60 years' experience in manufacturing stoves and fireplaces for the harshest of Arctic winters.

Furthermore, its knowledge of casting with premium grade iron is second to none. So much so, in fact, that all cast parts come with a 5 year guarantee.

Cast iron has many advantages - durability, better heat retention and longevity, as well as the ability to be moulded into a huge variety of shapes and textures, giving aesthetic beauty and immediate appeal whether your interior style is traditional or contemporary.

Over the decades, Dovre's product range has been developed and refined continuously. Today, its woodburning and multi-fuel stoves offer advanced cleanburn technology for improved combustion efficiency and care for the environment. Its airwash systems help keep the door glass clean, whilst there are also many models fuelled with the convenience of gas or electricity.



Wood is the better fuel in environmental terms as the amount of carbon dioxide released into the atmosphere is approximately the same as that absorbed by the tree during growth. It is also a renewable resource, particularly when derived from plantations and cultivated woodland. For optimum results, we recommend logs should be seasoned for 2 years or more to achieve a moisture content below 20%*. This will not only give up to twice the output of freshly felled timber but help avoid a build up of tar in your flue. Furthermore, if you can obtain hardwood logs this is better still, as they will have up to twice the calorific value of softwoods.

Whatever your choice - wood, multifuel, gas or electric - your Dovre stove or fireplace will be rugged, reliable and built to the uncompromising standards you would expect from our Scandinavian heritage.

* All efficiencies quoted in this brochure are for seasoned wood with a moisture content of less than 20%.

Front cover photograph: Astroline 3CB with pedestal



Traditional Insert and Canopied Fireplaces

44

Astroline Contemporary Stoves

28



FINISHES

- Traditional matt black
- Ivory enamel
- Midnight blue enamel
- Forest green enamel
- Majolica brown enamel
- Black enamel



Dovre 250CBW with short leg option

250

MULTI-FUEL & WOOD STOVES

APPROVED FOR SMOKE CONTROL AREAS

The Dovre 250 multi fuel is designed to suit a huge range of applications from a cottage kitchen to a modern town house living room; especially as it is approved for smoke control areas: It has a large glass door panel and ornately cast side panels both adding to the visual appeal: Manufactured from only premium grade cast iron; the 250 is at home whether burning wood (logs up to 30cm long may be used) or a variety of solid fuels; and is equipped with a sophisticated airwash system to keep the door glass cleaner: Matt black woodburning and woodburning-smokeless fuel versions with cleanburn for improved heating efficiency are also available: Shorter legs are an option on the 250CBW model:

- All cast iron construction ■
- Woodburning or multi fuel versions ■
- Airwash system ■
- Colour matched enamel flue pipe also available ■
- Maximum heat output 4.9kW ■
- High efficiency up to 77 ■
- Top or rear flue exit ■
- Flue diameter 125mm ■
- Weight 79kg ■

PRODUCT CODES

- DV-250CBS Matt black woodburner with cleanburn and airwash systems
- DV-250CBW Matt black woodburner/smokeless fuel with cleanburn
- DV-250 Matt black multi-fuel with riddling grate and airwash system
- DV-250BL Midnight blue enamel multi-fuel with riddling grate and airwash system
- DV-250BLK Black enamel multi-fuel with riddling grate and airwash system
- DV-250GR Forest green enamel multi-fuel with riddling grate and airwash system
- DV-250MB Majolica brown enamel multi-fuel with riddling grate and airwash system
- DV-250IV Ivory enamel multi-fuel with riddling grate and airwash system

TRADITIONAL STOVES



Dovre 250 multi fuel stove in traditional matt black



FINISHES

- Traditional matt black
- Ivory enamel
- Midnight blue enamel
- Forest green enamel
- Black enamel



Dovre 280 Gas conventional flue version with coal effect fire

280 GAS STOVES

An all new model; the 280 Gas blends Dovre's pedigree in casting with the latest gas flame technology: So the fire not only looks highly realistic but also provides you with effective and controllable warmth: There are two distinctive models - conventional flue with coal effect fire or balanced flue with log effect fire - and both even have the option of remote controls to allow you to adjust the flames and heat from the comfort of your armchair:

- All cast iron construction
- Conventional flue version with realistic coal effect fire
- Balanced flue version with realistic log effect fire
- Colour matched enamel flue pipe also available
- Optional remote controls
- Maximum heat output 3:6kW)CF - 3:3kW)BF
- Piezo ignition system requires no electricity supply
- Top or rear flue exit 125mm)CF - 152mm)BF
- LPG and Natural Gas versions available
- Automatic safety shutdown in the event of pilot light failure or flue blockage
- Weight 50kg)CF - 54:4kg)BF

PRODUCT CODES

280 CONVENTIONAL FLUE WITH COAL-EFFECT FIRE

Natural Gas
DV-280CFNG
DV-280CFNGIV
DV-280CFNGGR
DV-280CFNGBK
DV-280CFNGBL

LPG
DV-280CFLPG
DV-280CFLPGIV
DV-280CFLPGGR
DV-280CFLPGBK
DV-280CFLPGBL

280 BALANCED FLUE WITH LOG-EFFECT FIRE

Natural Gas
DV-280BFNG
DV-280BFNGIV
DV-280BFNGGR
DV-280BFNGBK
DV-280BFNGBL

LPG
DV-280BFLPG
DV-280BFLPGIV
DV-280BFLPGGR
DV-280BFLPGBK
DV-280BFLPGBL

Matt black
Ivory enamel
Forest green enamel
Black enamel
Midnight blue enamel

HEAT OUTPUT

280 CONVENTIONAL FLUE

Energy Input: Nat. Gas: 4.6kW, LPG: 4.4kW
Heat Output: Nat. Gas: 3.6kW, LPG: 3.2kW

280 BALANCED FLUE

Energy Input: Nat. Gas: 4.2kW, LPG: 4.1kW
Heat Output: Nat. Gas: 3.3kW, LPG: 3.2kW



OPTIONAL REMOTE CONTROLS†
DV-8455: Standard
DV-8456: Programmable

† Once the pilot has been ignited manually, the Standard remote control allows you to vary the flame height and heat output from your armchair. The Programmable version also enables you to set the stove to switch itself on and off twice a day, to the temperature you select, so that you can wake up or come home to a cosy room and glowing fire.



TRADITIONAL STOVES

Dovre 280 Gas balanced flue version with log effect fire

TRADITIONAL STOVES



Dovre 280 Electric in ivory enamel



FINISHES

- Traditional matt black 
- Ivory enamel 
- Midnight blue enamel 



Dovre 280 Electric in traditional matt black

280 ELECTRIC STOVES

If you do not have a chimney or want to locate a stove in a space where it would be difficult to install a flue then the electric version of the 280 could be the answer: Once plugged in to a normal 13amp socket; you simply use the remote control to turn it on or off; adjust the heat or to select one of the 25 combinations of glow-flame speed that make the stove's log fire one of the most authentic available: It truly is real fire ambience at the press of a button

- All cast iron construction
- Exceptionally realistic log effect with hand painted fuel bed and logs
- Choose any combination of 5 glow and 5 flame speed settings
- Discreetly concealed fan heater with 1kW and 2kW settings
- All functions operated from remote control so no bending
- Requires no flue; hearth or chimney
- Plugs into standard 13amp socket
- Safe to use in most locations around the home or conservatory
- Can be moved from room to room
- Weight 50kg

PRODUCT CODES

- DV-280E Matt black, log-effect fire
- DV-280E8L Midnight blue enamel, log-effect fire
- DV-280EIV Ivory enamel, log-effect fire



FINISHES

- Traditional matt black
- Ivory enamel
- Midnight blue enamel
- Forest green enamel
- Majolica brown enamel
- Black enamel



Dovre 425 multi fuel stove in forest green enamel

425 MULTI-FUEL STOVES

Available in a selection of deep enamel finishes as well as traditional matt black; the Dovre 425 has the style and performance to bring a warming glow to many a home: The woodburning version features Dovre's latest cleanburn system whilst the multi fuel version; complete with riddling grate; is capable of burning a variety of solid fuels or logs and incorporates an airwash system to help keep the window clean:

- All cast iron construction ■
- Woodburning or multi fuel versions ■
- Airwash system ■
- Colour matched enamel flue pipe also available ■
- Maximum heat output 8kW ■
- High efficiency up to 83 ■
- Top or rear flue exit ■
- Flue diameter 150mm ■
- Weight 130kg ■

PRODUCT CODES

- DV-425CBW Matt black woodburner with cleanburn
- DV-425CBWL Matt black woodburner with cleanburn and lattice door
- DV-425 Matt black multi-fuel with riddling grate and airwash system
- DV-425BL Midnight blue enamel multi-fuel with riddling grate and airwash system
- DV-425BLK Black enamel multi-fuel with riddling grate and airwash system
- DV-425GR Forest green enamel multi-fuel with riddling grate and airwash system
- DV-425MJB Majolica brown enamel multi-fuel with riddling grate and airwash system
- DV-425IV Ivory enamel multi-fuel with riddling grate and airwash system



Dovre 425 multi fuel stove in traditional matt black





TRADITIONAL STOVES



Dovre 425 Gas stove in ivory enamel



FINISHES

- Traditional matt black 
- Ivory enamel 
- Midnight blue enamel 
- Forest green enamel 
- Black enamel 



Dovre 425 Gas in traditional matt black

425 GAS STOVES

Incorporating up to the minute gas fire technology, Dovre's 425 Gas stove features all the charm and atmosphere of a superb log effect fire with exceptionally realistic glow and gently dancing flames: It is available in both balanced flue and conventional flue versions: Add to this a choice of five colours; top or rear flue exits; natural gas or LPG variants and remote control options and you should be able to find the perfect stove for your home:

- All cast iron construction
- Realistic log effect fire
- Conventional and balanced flue versions
- Colour matched enamel
- flue pipe also available
- Optional remote controls
- Maximum heat output 5.3kW
- Piezo ignition system requires no electricity supply
- LPG and Natural Gas versions available
- Automatic safety shutdown in the event of pilot light failure or flue blockage
- Top or rear flue exit
- Flue diameter 125mm JCF - 152mm JBF
- Weight 74kg JCF - 81.5kg JBF

PRODUCT CODES

425 CONVENTIONAL FLUE

| Natural Gas | LPG |
|--------------|---------------|
| DV-425CFNG | DV-425CFLPG |
| DV-425CFNGIV | DV-425CFLPGIV |
| DV-425CFNGGR | DV-425CFLPGGR |
| DV-425CFNGBK | DV-425CFLPGBK |
| DV-425CFNGBL | DV-425CFLPGBL |

425 BALANCED FLUE

| Natural Gas | LPG | Finish |
|--------------|---------------|---------------------------------------|
| DV-425BFNG | DV-425BFLPG | Matt black, log-effect fire |
| DV-425BFNGIV | DV-425BFLPGIV | Ivory enamel, log-effect fire |
| DV-425BFNGGR | DV-425BFLPGGR | Forest green enamel, log-effect fire |
| DV-425BFNGBK | DV-425BFLPGBK | Black enamel, log-effect fire |
| DV-425BFNGBL | DV-425BFLPGBL | Midnight blue enamel, log-effect fire |

HEAT OUTPUT

425 CONVENTIONAL FLUE

Energy Input: Nat. Gas: 6.6kW, LPG: 6.4kW
Heat Output: Nat. Gas: 5.3kW, LPG: 5.1kW

425 BALANCED FLUE

Energy Input: Nat. Gas: 6.45kW, LPG: 6.1kW
Heat Output: Nat. Gas: 5.3kW, LPG: 5.0kW



OPTIONAL REMOTE CONTROLS[†]
DV-8455: Standard
DV-8456: Programmable

[†] Once the pilot has been ignited manually, the Standard remote control allows you to vary the flame height and heat output from your armchair. The Programmable version also enables you to set the stove to switch itself on and off twice a day, to the temperature you select, so that you can wake up or come home to a cosy room and glowing fire.

FINISHES

- Traditional matt black
- Ivory enamel
- Midnight blue enamel



Dovre 425 Electric in traditional matt black

425 ELECTRIC STOVES

Instant glow; instant flames and instant heat; that's the promise of the impressive new 425 Electric: You can select from 5 different flame speeds and 5 different glow settings to provide your ideal style of fire: There are even reflective sides to ensure the flames appear realistic from all angles so whether you use the built in fan heater or not you can enjoy a perfect picture of warmth at anytime:

- All cast iron construction
- Exceptionally realistic log effect with hand painted fuel bed and logs
- Choose any combination of 5 glow and 5 flame speed settings
- Discreetly concealed fan heater with 1kW and 2kW settings
- All functions operated from remote control so no bending
- Requires no flue; hearth or chimney
- Plugs into standard 13amp socket
- Safe to use in most locations around the home or conservatory
- Can be moved from room to room
- Weight 74kg

PRODUCT CODES

- DV-425E Matt black, log-effect fire
- DV-425EBL Midnight blue enamel, log-effect fire
- DV-425EIV Ivory enamel, log-effect fire



TRADITIONAL STOVES

Dovre 425 Electric in traditional matt black

TRADITIONAL STOVES



Dovre 500 with clear door

FINISHES

Traditional matt black 



Dovre 500CB woodburner with lattice door

500 MULTI-FUEL STOVES

✓ WOODBURNER APPROVED
FOR SMOKE CONTROL AREAS

The Dovre 500 is a masterpiece of casting proficiency and up to date technology: Not only does it offer classic stove appeal but it also features a separate ashpan door; for easier removal of ash; and a choice of six different versions: The multi fuel model is available with either a fixed grate or a riddling grate; and has the further option of clear or lattice doors: The woodburner; on the other hand; incorporates a special cleanburn system that is so effective it has been approved by the Department of the Environment for use in smoke control areas: It; too; has the option of a lattice door:

- All cast iron construction
- Woodburning or multi fuel versions
- Airwash system
- Colour matched enamel flue pipe also available
- Maximum heat output 8kW
- High efficiency up to 79
- Top or rear flue exit
- Flue diameter 150mm
- Weight 118 124kg

PRODUCT CODES

- DV-500CBW Matt black woodburner with cleanburn - clear door
- DV-500CBWL Matt black woodburner with cleanburn - lattice door
- DV-500MFF Matt black multi-fuel with fixed grate and airwash system - clear door
- DV-500MFFL Matt black multi-fuel with fixed grate and airwash system - lattice door
- DV-500MFR Matt black multi-fuel with riddling grate and airwash system - clear door
- DV-500MFRL Matt black multi-fuel with riddling grate and airwash system - lattice door



All controls are cleverly hidden behind the ashpan door

FINISHES

Traditional matt black



Dovre 500 Electric with clear door

500 ELECTRIC STOVES

No fuel to store; no cleaning out needed; just the enjoyment of a glowing coal effect fire and flickering flames: A 2kW fan assisted heater built into the base of the Dovre 500 Electric provides plenty of warmth whilst requiring no chimney: This means the stove can be sited anywhere there is a suitable wall socket and it can even be moved from room to room: So you can now have a real stove anywhere:

- All cast iron construction
- Superior fire effect with glowing coals and flickering flames
- Fire effect can be used independently of heating
- Safe to use in most locations around the home or conservatory
- Can be moved from room to room
- Requires no flue; hearth or chimney
- 1kW or 2kW fan assisted output from cleverly concealed heater
- Plugs into standard 13 amp socket
- Choice of plain or lattice door
- Weight 70kg

PRODUCT CODES

- DV-500EP Matt black with clear door
- DV-500EL Matt black with lattice door

TRADITIONAL STOVES



Dovre 500 Electric with lattice door

TRADITIONAL STOVES



Dovre 555 multi fuel stove

FINISHES

Traditional matt black ■



Dovre 555 multi fuel stove

555 MULTI-FUEL STOVE

A truly flexible choice as a medium sized stove; the Dovre 555 comes complete with a fixed grate for burning smokeless fuel or coal; yet can burn wood with equal proficiency: The design also includes adjustable leg height to suit different openings and aid installation and there is even a side loading door to allow the fuelling of logs up to 44cm long:

- All cast iron construction
- Multi fuel operation
- Cleanburn and airwash systems
- Maximum heat output 8kW
- High efficiency up to 79
- Top or rear flue exit
- Flue diameter 150mm
- Weight 140kg

PRODUCT CODES

DV555 Matt black multi-fuel with cleanburn and airwash



Dovre 640CB woodburning stove

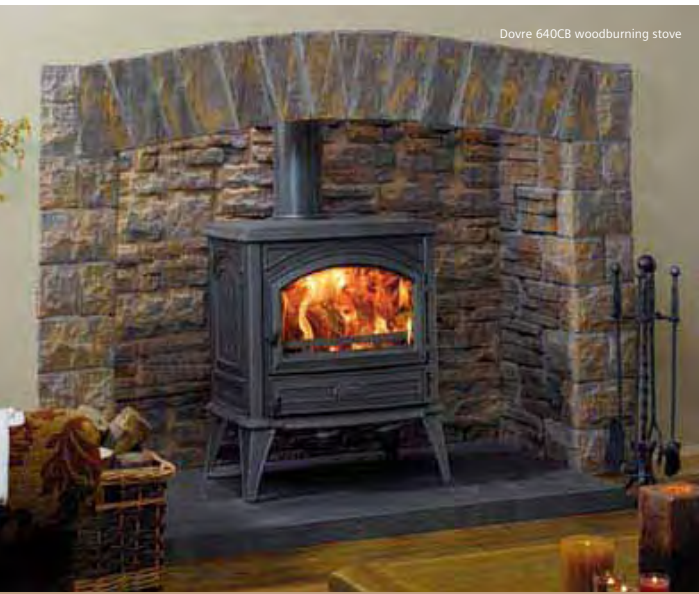

FINISHES

Traditional matt black



640CB WOOD STOVE

This well proportioned stove features a side loading door as well as a front glass door and separate ashpan door. The side door allows logs of up to 50cm in length to be loaded into the stove so that less sawing is required when owners are providing their own timber. There is also a cleanburn system for improved fuel efficiency; an airwash system to help keep the door glass clean and a choice of top or rear flue outlets:

- All cast iron construction
- Woodburner
- Cleanburn and airwash systems
- Side door for loading
- Maximum heat output 9kW
- High efficiency up to 79
- Top or rear flue exit
- Flue diameter 150mm
- Weight 158kg

PRODUCT CODES

DV-640CBW Matt black woodburner with cleanburn and airwash

TRADITIONAL STOVES



Dovre 640CB woodburning stove

TRADITIONAL STOVES



Dovre 700CBW

FINISHES

Traditional matt black 



Dovre 700MFF

700

MULTI-FUEL & WOOD STOVES

 WOODBURNER APPROVED FOR SMOKE CONTROL AREAS

Like the woodburning version of the Dovre 500; the larger 700CBW also incorporates special cleanburn technology that is so efficient the Department of the Environment has approved it for use in smoke control areas: There is also an airwash system to help keep the panoramic window clean:

Alternatively; you can select the 700 multi fuel: This model has a fixed grate that is perfect for burning smokeless fuels; peat or logs and also includes Dovre's airwash system to ensure you enjoy the best possible view of your fire; as well as a useful side door for the loading of longer logs:

- All cast iron construction
- Woodburning or multi fuel versions
- Airwash system
- Maximum heat output 11kW (CBW) - 12kW (MFF)
- Top or rear flue exit
- Flue diameter 150mm
- Weight 180kg (CBW) - 175kg (MFF)

PRODUCT CODES

- DV-700CBW Matt black woodburner with cleanburn and airwash
- DV-700MFF Matt black multifuel with fixed grate and airwash system



FINISHES

Traditional matt black



Dovre 760CB

760CB

WOOD STOVE

Big brother to the Dovre 640CB; the 760CB is a truly impressive stove: It features cleanburn; an airwash system; a side loading door as well as a glass front door; separate ashpan door and up to 11kW of heat: The side door allows logs of up to 52cm to be loaded so there is less sawing if you are using your own wood:

- All cast iron construction
- Woodburner
- Cleanburn and airwash systems
- Side door for loading
- Maximum heat output 11kW
- High efficiency up to 75
- Top or rear flue exit
- Flue diameter 150mm
- Weight 180kg

PRODUCT CODES

DV-760CBW Matt black woodburner with cleanburn and airwash



Dovre 760CB

ASTROLINE CONTEMPORAR · STONES



Astroline 1CB

FINISHES

Anthracite 



Astroline 1CB

1CB

ASTROLINE 1 WOOD STOVE

With superb modern styling; the Astroline 1CB takes the design of cast iron stoves into the 21st Century: The high elevations not only represent a style statement but they also permit extra heating capacity; as logs up to 37.5cm in length can be positioned in a wigwam shape and provide up to 10kW of warmth ideal for larger, open plan living spaces:

Further; the Astroline 1CB features all of Dovre's latest cleanburn technology; including a secondary combustion system to reduce soot emissions and to improve fuel efficiency; whilst a powerful airwash system helps to keep the huge ceramic glass panel clean: Together; they create exceptional flames and a wonderful view of the fire:

- All cast iron construction ■
- Woodburner ■
- Cleanburn and airwash systems ■
- Maximum heat output 10kW ■
- High efficiency up to 78 ■
- Top or rear flue exit ■
- Flue diameter 150mm ■
- Weight 140kg ■

PRODUCT CODES

DV-ASTBLK Anthracite woodburner with anthracite side panels, cleanburn and airwash system



FINISHES

Anthracite 

Astroline 2CB

2CB

ASTROLINE 2 WOOD STOVE

Smaller sister to the Astroline 1CB and with similar contemporary styling; the Astroline 2CB features the latest cleanburn and airwash technology for impressive heating performance and efficiency: The large ceramic glass panel also provides the superb views and comforting ambience that only a real log fire can bring:

- All cast iron construction
- Woodburner
- Cleanburn and airwash systems
- Maximum heat output 8kW
- High efficiency up to 78
- Top or rear flue exit
- Flue diameter 150mm
- Weight 140kg

PRODUCT CODES

DV-AST2BLK Anthracite woodburner with anthracite side panels, cleanburn and airwash system



ASTROLINE CONTEMPORAR STOVES

Astroline 2CB



Astroline 3CB with wood store



Astroline 3CB with pedestal

FINISHES

Anthracite 

3CB

ASTROLINE 3 MULTI-FUEL & WOOD STOVES

With sleek and contemporary styling; Dovre's new Astroline 3 not only offers you an exceptional view of the fire but also a choice of two distinctive variants as well as either woodburning or multi fuel versions of each: The state of the art cleanburn combustion system provides stunning flames within the firebox and these can be seen from more than 180° thanks to the angled glass side panels and the large main window: Combustion and efficiency is also aided by an outside air connection which can reduce draughts within your room:

Choose from the Astroline 3CB with a pedestal or; alternatively; the design with a wood store base:

- All cast iron construction
- Woodburning or multi fuel versions
- Cleanburn system
- Outside combustion air facility
- Maximum heat output 10kW
- High efficiency up to 75%
- Top or rear flue exit
- Flue diameter 150mm
- Weight 158 - 171kg

PRODUCT CODES

- DV-ASTRO3CB/P Anthracite woodburner with pedestal base, cleanburn and outside combustion air connection
- DV-ASTRO3CB/WB Anthracite woodburner with wood store base, cleanburn and outside combustion air connection
- DV-ASTRO3MF/P Anthracite multi-fuel with pedestal base, riddling grate, cleanburn and outside combustion air connection
- DV-ASTRO3MF/WB Anthracite multi-fuel with wood store base, riddling, cleanburn and outside combustion air connection

FINISHES

Anthracite 



Astroline 4CB with pedestal

4CB

ASTROLINE 4 MULTI-FUEL & WOOD STOVES

Similar in looks to the Astroline 3CB; this model is also available in either woodburning or multi fuel versions and with a choice of pedestal or wood store bases:

Featuring an extensive front window and glass side panels; you are able to enjoy to the full the exceptional swirling flames produced by Dovre's very latest cleanburn system: An external combustion air facility also helps to reduce draughts in the room as well as improve heating efficiency and with up to 10kW of warmth that's a very cosy thought for any winter's night

- All cast iron construction
- Woodburning or multi fuel versions
- Cleanburn system
- Outside combustion air facility
- Maximum heat output 10kW
- High efficiency up to 75
- Top or rear flue exit
- Flue diameter 150mm
- Weight 168 181kg

PRODUCT CODES

- DV-ASTRO4CB/P Anthracite woodburner with pedestal base, cleanburn and outside combustion air connection
- DV-ASTRO4CB/WB Anthracite woodburner with wood store base, cleanburn and outside combustion air connection
- DV-ASTRO4MF/P Anthracite multi-fuel with pedestal base, riddling grate, cleanburn and outside combustion air connection
- DV-ASTRO4MF/WB Anthracite multi-fuel with wood store base, riddling, cleanburn and outside combustion air connection

ASTROLINE CONTEMPORARY STOVES



Astroline 4CB with wood store

ASTROLINE CONTEMPORARY STOVES



Astroline 350CB

FINISHES

Anthracite 



Astroline 350CB-3

350CB

ASTROLINE WOOD STOVES

Designed to complement the most modern architecture and interior design; the Astroline 350CB brings its own unique style to the traditional world of stoves: The large flame view area; particularly on the version that has glass side panels; and sophisticated cleanburn will provide you with the home heating pleasure for which Dovre is famed:

- All cast iron construction ■
- Woodburner ■
- Cleanburn and airwash systems ■
- Maximum heat output 6kW ■
- High efficiency up to 81 ■
- Top or rear flue exit ■
- Flue diameter 125mm ■
- Weight 110kg ■

PRODUCT CODES - ASTROLINE 350CB

DV-350CBW Anthracite woodburner with cleanburn and airwash system

PRODUCT CODES - ASTROLINE 350CB/3

DV-350CB/3 Anthracite woodburner with glass side panels, cleanburn & airwash system



FINISHES

Anthracite 



Astroline 360CB-3

360CB

ASTROLINE WOOD STOVES

Wider than the Astroline 350CB; and with additional heating capacity; this superb stove also features Dovre's very latest cleanburn and airwash technology: So you will enjoy an impressive view of the flames – even more so with the 3 sided version – as well as all the comforts of a real fire:

- All cast iron construction
- Woodburner
- Cleanburn and airwash systems
- Maximum heat output 8kW
- High efficiency up to 74
- Top or rear flue exit
- Flue diameter 125mm
- Weight 110kg

PRODUCT CODES - ASTROLINE 360CB

DV-360CBW Anthracite woodburner with cleanburn and airwash system

PRODUCT CODES - ASTROLINE 360CB/3

DV-360CB/3 Anthracite woodburner with glass side panels, cleanburn & airwash system

ASTROLINE CONTEMPORARY STOVES



Astroline 360CB

CASSETTE FIREPLACES



Dovre 2510 cassette fire



FINISHES

■ Anthracite



2510 DOUBLE-SIDED CASSETTE FIRE

This superb cassette is a dedicated double sided design that is ideal for new build and major renovation projects: It offers both excellent heating capacity)complete with thermostat and integral fan unit for quicker warming of the room and great views of the fire to adjacent rooms using a central flue: The 2510 can burn wood or smokeless fuels and produces up to 9kW of heat:

- All cast iron construction
- Woodburner with multi fuel option
- Fan assisted double sided cassette with thermostatic control
- Maximum heat output 9kW
- High efficiency up to 78
- Flue diameter 150mm
- Weight 170kg

PRODUCT CODES

DV-2510DSMF Anthracite woodburner with fan-assisted air circulation
DV-K.10.25D/3 Optional 3 sided frame
DV-K.10.25D/4 Optional 4 sided frame
DV-K2100 Optional multi-fuel basket

Note: a standard 13amp domestic electricity supply is also required for this appliance to power the built-in electric fan.

FINISHES

- Traditional matt black



2520 CASSETTE FIRE

This large bow fronted cassette features a sophisticated airwash system to ensure you enjoy a superbly panoramic view of the fire: Although a dedicated woodburner; the multi fuel basket option also allows you to burn smokeless fuels should you wish: Whichever your preference; the 2520 will heat your room with a gentle stream of warm convected air or; by using the integral electric fans; a powerful flow of thermostatically controlled heat:

- All cast iron construction
- Woodburner with multi fuel option
- Cleanburn and airwash systems
- Fan assisted convection system with thermostatic control
- Suitable for use with a room heating convection system
- Maximum heat output 11kW
- High efficiency up to 80
- Flue diameter 150mm
- Weight 190kg

PRODUCT CODES

- DV-2520BS Matt black woodburner with convection system and airwash system
- DV-K20.25/3 Optional 3-sided frame
- DV-K2100 Optional multi-fuel basket

Note: a standard 13amp domestic electricity supply is also required for this appliance to power the built-in electric fan.



CASSETTE FIREPLACES

The 2520 cassette fire is shown left with optional 3 sided frame

INSERT CANOPIED FIREPLACES



Dovre 1800 fireplace with optional canopy; plinth and side panels



FINISHES

■ Traditional matt black



1800 FIREPLACE

For smaller fireplaces and rooms; the Dovre 1800 has all the advantages of larger models; including high efficiency and excellent heat output; but with more compact dimensions: The 1800 is also offered with a choice of accessories to help you create your own individual fireplace setting:

- All cast iron construction
- Multi fuel
- Suitable for use in smaller inglenooks (with optional steel canopy; base plinth and side panels or as a built in fireplace)
- Suitable for use with a room heating convection system
- Maximum heat output 8kW
- High efficiency up to 80
- Flue diameter 150mm
- Weight 75kg

PRODUCT CODES

DV-1800W Matt black multi-fuel

Accessories For canopies, base plinths and side panels, see pages 60 & 61

FINISHES

- Traditional matt black



2000 FIREPLACE

Complete with integral riddling grate; the Dovre 2000 fireplace has been designed to burn wood or a variety of smokeless fuels: It also has the option of a back boiler that can provide hot water when the fire is being used:

- All cast iron construction
- Multi fuel
- Suitable for use in smaller inglenooks (with optional steel canopy; base plinth and side panels or as a built in fireplace)
- Suitable for use with a room heating convection system
- Maximum heat output 11kW
- High efficiency up to 71
- Flue diameter 186mm
- Weight 165kg

PRODUCT CODES

- DV-2000MFR Matt black multi-fuel
Accessories For canopies, base plinths and side panels, see pages 60 & 61
DV-DGBS2 Optional back boiler (1.5kW)



INSERT CANOPIED FIREPLACES

Dovre 2000 fireplace with optional canopy and side panels

INSERT CANOPIED FIREPLACES



Dovre 2300CB fireplace with optional canopy, plinth and side panels



FINISHES

Traditional matt black



Dovre 2300CB as a built in fireplace

2300CB FIREPLACE

As a dedicated woodburner the Dovre 2300CB is equally at home as a built in fireplace with a sophisticated convection system or in a dramatic inglenook: Open the doors and enjoy the full ambience of a real fire; close the doors and a sophisticated airwash system keeps the glass cleaner for a full view of the fire: With these features and the inclusion of an aerated baffle for greater efficiency and lower emissions; the 2300CB takes crackling log fires into a new era:

- All cast iron construction
- Cleanburn woodburner
- Suitable for use in smaller inglenooks (with optional steel canopy; base plinth and side panels) or as a built in fireplace
- Suitable for use with a room heating convection system
- Maximum heat output 9kW
- High efficiency up to 77
- Flue diameter 186mm
- Weight 150kg

PRODUCT CODES

DV-2300W Matt black woodburner with cleanburn and airwash system
Accessories For canopies, base plinths and side panels, see pages 60 & 61

FINISHES

- Traditional matt black



Dovre 2400CB showing impressive Panorama door

2400CB FIREPLACE

This model can either be built into a fireplace or combined with an optional canopy to create a stunning centrepiece for large fireplace openings and inglenooks: With a 9kW capacity and suitable for wood and smokeless fuels; the 2400CB incorporates a state of the art cleanburn system and is offered in either standard or Panorama versions: The standard model features bi fold doors with 4 windows whilst the Panorama has a single door with a large, elegantly curved window for maximum view of your fire:

- All cast iron construction
- Cleanburn woodburner
- Suitable for use in smaller inglenooks (with optional steel canopy and side panels) or as a built in fireplace
- Maximum heat output 9kW
- High efficiency up to 72
- Flue diameter 188mm
- Weight 130kg

PRODUCT CODES

- DV-2400CB Matt black woodburner with cleanburn, airwash and bifold doors
DV-2400CBPAN Matt black woodburner with cleanburn, airwash and Panorama door
Accessories For canopy and side panels see pages 60 & 61.



INSERT CANOPIED FIREPLACES

Dovre 2400CB with optional canopy and bifold doors

INSERT CANOPIED FIREPLACES



Dovre 2700 fireplace with optional canopy and side panels:



FINISHES

Traditional matt black

Dovre 2700 built into a fireplace



2700 FIREPLACE

Whether you install the 2700 a part of an inglenook setting or build it into a fireplace this classic Dovre model allows you to enjoy all the character of a real fire with the doors open; or a slower, more efficient combustion with the doors closed: Inserted into a fireplace setting; you can even use the special convection chamber to duct warm air to outlet grilles above the fireplace or even distribute it to other parts of your home:

- All cast iron construction
- Woodburner
- Suitable for use in smaller inglenooks (with optional steel canopy; base plinth and side panels) or as a built in fireplace
- Suitable for use with a room heating convection system
- Maximum heat output 10kW
- High efficiency up to 77
- Flue diameter 186mm
- Weight 135kg

PRODUCT CODES

DV-2700W Matt black woodburner with airwash system

Accessories For canopies, base plinths and side panels see pages 60 & 61

FINISHES

■ Anthracite



2900 FIREPLACE

A high efficiency; woodburning fireplace with an impressively large door giving a superb view of the fire: The guillotine style door glides up and down on a counterbalanced system for easy loading of the fuel: Whilst the 2900 produces up to 12kW of radiated heat; the skilful design also incorporates an Air Convection Chamber which allows you to duct warm air to other parts of the room or to adjacent living spaces:

- All cast iron construction
- Woodburner
- Built in fireplace with the option of a room heating convection system
- Maximum heat output 12kW
- High efficiency up to 65
- Flue diameter 200mm
- Weight 225kg

PRODUCT CODES

DV-2900RGDC Anthracite woodburner with airwash

DVK29/4COMP Optional 4-sided frame

NB This fireplace needs to be built into an existing chimney breast or a false stud wall and will generally need structural work. Please contact your Dovre retailer for further installation details.



2900 fireplace with guillotine door and optional 4 sided frame

INSERT CANOPIED FIREPLACES





Dovre 1800NG with optional canopy and side panels

FINISHES

- Traditional matt black



1800 GAS FIREPLACE

Whether built in as part of a conventional fireplace or combined with one of Dovre's canopies to create an impressive inglenook setting; this superb fireplace offers traditional style and atmosphere with the convenience of gas: The turn of a switch is all you need to enjoy a blazing, realistic looking fire of logs and coals: The gas fires can also be purchased separately to allow you to convert an existing Dovre fireplace from woodburning to gas:

- All cast iron construction
- For use with a conventional chimney-flue system
- Piezo ignition system requires no electricity supply
- Whisper quiet burners with adjustable heat output
- Mixed log and coal effect fire for a realistic flame pattern
- Natural gas and LPG versions available
- Automatic safety shutdown in the event of pilot light failure or flue blockage
- Full range of accessories including canopies; base plinths and side panel units: See pages 62 and 63
- Energy input Nat: Gas 10:5kW - LPG 10:5kW
- Maximum heat output 2:5kW
- Flue diameter 150mm
- Weight 75kg

PRODUCT CODES

- DV-1800NG Matt black fireplace with mixed coal/log-effect natural gas fire
- DV-1800LPG Matt black fireplace with mixed coal/log-effect LPG fire
- Accessories For canopies, base plinths and side panels see pages 60 & 61
- DV-1800PLUSNG Natural gas mixed coal and log-effect fire conversion kit only
- DV-1800PLUSLPG LPG mixed coal and log-effect fire conversion kit only

FINISHES



Anthracite



2700 GAS FIREPLACE

Enjoy all the convenience of a realistic gas fire with the traditional characteristics of a built in or canopied fireplace in the excellent 2700 Gas: The fireplace itself boasts an all cast iron construction for authenticity and longevity whilst the mixed coal and log effect gas fire creates the cosy glow; flickering flames and comforting warmth you would expect from genuine real fire ambience: Heat output is adjustable up to 3.5kW:

- All cast iron construction
- For use with a conventional chimney-flue system
- Piezo ignition system requires no electricity supply
- Whisper quiet burners with adjustable heat output
- Mixed log and coal effect fire for a realistic flame pattern
- Natural gas and LPG versions available
- Automatic safety shutdown in the event of pilot light failure or flue blockage
- Full range of accessories including canopies; base plinths and side panel units: See pages 62 and 63
- Energy input Nat: Gas 16.5kW - LPG 15kW
- Maximum heat output 3.5kW
- Flue diameter 200mm
- Weight 165kg

PRODUCT CODES

| | |
|----------------|--|
| DV-2700NG | Matt black fireplace with mixed coal/log-effect natural gas fire |
| DV-2700LPG | Matt black fireplace with mixed coal/log-effect LPG fire |
| Accessories | For canopies, base plinths and side panels see pages 60 & 61 |
| DV-2000PLUSNG | Natural gas mixed coal and log-effect fire conversion kit only |
| DV-2000PLUSLPG | LPG mixed coal and log-effect fire conversion kit only |



Dovre 2700NG with optional canopy, plinth and side panels

INSERT CANOPIED FIREPLACES



CANOPIES PLINTHS AND SIDE PANELS

Our range of canopies, plinths and side panels has been specially designed to complement Dove appliances whether installed freestanding in an inglenook or a recessed fireplace. They are manufactured to the highest standards and help ensure a lifetime of fireside pleasure:

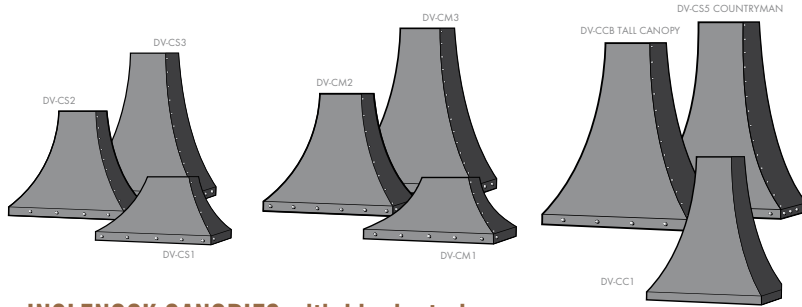

INGLENOOK CANOPIES with black studs

Non-standard heights available to special order. Please allow 3-4 weeks for delivery.

1800 FIREPLACE

| CODE | DESCRIPTION | HEIGHT | BASE WIDTH | TOP WIDTH | BASE DEPTH | TOP DEPTH |
|--------|--------------------|--------|------------|-----------|------------|-----------|
| DV-CM1 | Small 1800 Canopy | 325 | 530 | 260 | 310 | 145 |
| DV-CM2 | Medium 1800 Canopy | 700 | 685 | 260 | 460 | 235 |
| DV-CM3 | Tall 1800 Canopy | 950 | 685 | 230 | 460 | 235 |

2000 & 2700 FIREPLACES

| CODE | DESCRIPTION | HEIGHT | BASE WIDTH | TOP WIDTH | BASE DEPTH | TOP DEPTH |
|--------|-------------------------|--------|------------|-----------|------------|-----------|
| DV-CS1 | Small 2700 Canopy | 360 | 710 | 410 | 400 | 260 |
| DV-CS2 | Medium 2000/2700 Canopy | 685 | 900 | 350 | 570 | 300 |
| DV-CS3 | Tall 2000/2700 Canopy | 1070 | 900 | 300 | 560 | 290 |

'COUNTRYMAN' FOR 2000 & 2700 FIREPLACES

The Traditional 'olde worlde' styled canopy with heavy, more rugged, black studded strap trim

| CODE | DESCRIPTION | HEIGHT | BASE WIDTH | TOP WIDTH | BASE DEPTH | TOP DEPTH |
|--------|-------------------|--------|------------|-----------|------------|-----------|
| DV-CS5 | Countryman Canopy | 1070 | 900 | 300 | 560 | 290 |

2300CB FIREPLACES

| CODE | DESCRIPTION | HEIGHT | BASE WIDTH | TOP WIDTH | BASE DEPTH | TOP DEPTH |
|--------|------------------|--------|------------|-----------|------------|-----------|
| DV-CCB | Tall 2300 Canopy | 835 | 820 | 260 | 490 | 235 |

2400 FIREPLACE

| CODE | DESCRIPTION | HEIGHT | BASE WIDTH | TOP WIDTH | BASE DEPTH | TOP DEPTH |
|--------|-------------|--------|------------|-----------|------------|-----------|
| DV-CC1 | 2400 Canopy | 805 | 755 | 300 | 535 | 260 |

All dimensions are quoted in millimetres

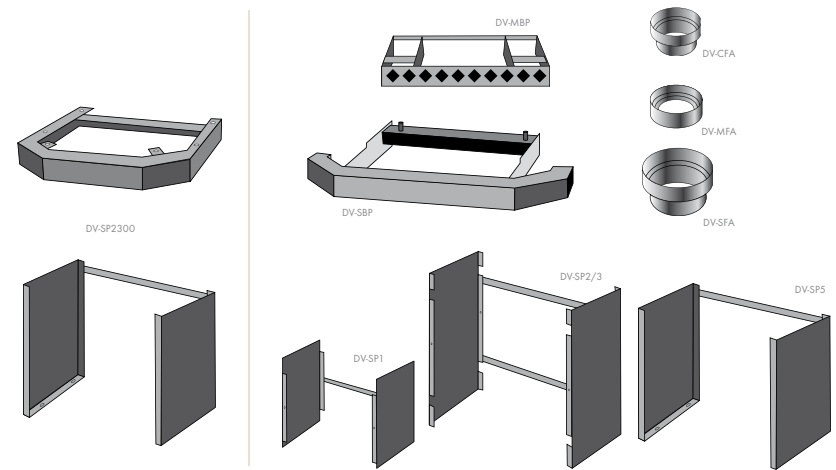

1800, 2000, 2400 & 2700 FIREPLACES

PLINTH

Designed to improve convection on appliances used in freestanding installations, base plinths will also enhance the visual appearance of your fireplace

| CODE | DESCRIPTION | HEIGHT | WIDTH | DEPTH |
|--------|-------------------------------|--------|-------|-------|
| DV-MBP | 1800 Base Plinth (Black) | 80 | 510 | 315 |
| DV-SBP | 2000/2700 Base Plinth (Black) | 80 | 725 | 485 |

SIDE PANEL UNITS

For use with freestanding type installations where the sides of the appliance may be exposed to view, for example with an extra wide inglenook.

| CODE | DESCRIPTION | HEIGHT | WIDTH | DEPTH |
|--------|------------------------------|--------|-------|-------|
| DV-SP1 | 1800 Side Panel Unit (Black) | 470 | 530 | 290 |
| DV-SP2 | 2700 Side Panel Unit (Black) | 740 | 720 | 400 |
| DV-SP3 | 2000 Side Panel Unit (Black) | 780 | 720 | 350 |
| DV-SP5 | 2400 Side Panel Unit (Black) | 520 | 635 | 400 |

FLUE ADAPTORS

| CODE | DESCRIPTION | FLUE PIPE DIAMETER |
|--------|------------------------|-------------------------|
| DV-MFA | 1800 Flue Adaptor | 5 1/2" - 6" (134 - 153) |
| DV-SFA | 2000/2700 Flue Adaptor | 7 1/2" - 8" (185 - 204) |

2300CB FIREPLACES

PLINTH, SIDE PANEL & FLUE ADAPTOR

| CODE | DESCRIPTION | HEIGHT | WIDTH | DEPTH |
|-----------|---|--------|-------------------------|-------|
| DV-SP2300 | Side Panel and Base Plinth kit for 2300CB (Black) | 520 | 670 | 535 |
| DV-CFA | Flue Adaptor | | 7 1/2" - 8" (185 - 204) | |

All dimensions are quoted in millimetres

FLUE PIPE

MATCHING ENAMELLED FLUE PIPE

For the fully colour coordinated installation of your stove; and optimum performance; we offer high quality enamel coloured flue pipe: However; please note that due to the different production processes we cannot guarantee a perfect match between pipe and stove:

The flue pipe diameters required for each model are given on each of the product pages:



ACCESSORIES & STOVE CARE



| | BLACK ENAMEL | MIDNIGHT BLUE ENAMEL | FOREST GREEN ENAMEL | IVORY ENAMEL |
|----------------------------------|--------------|----------------------|---------------------|--------------|
| 127mm diameter | | | | |
| 305mm (1') straight without door | DV-F512BLK | DV-F512BL | DV-F512GR | DV-F512IV |
| 610mm (2') straight without door | DV-F524BLK | DV-F524BL | DV-F524GR | DV-F524IV |
| 915mm (3') straight without door | DV-F536BLK | DV-F536BL | DV-F536GR | DV-F536IV |
| 305mm (1') straight with door | DV-FD512BLK | DV-FD512BL | DV-FD512GR | DV-FD512IV |
| 610mm (2') straight with door | DV-FD524BLK | DV-FD524BL | DV-FD524GR | DV-FD524IV |
| 915mm (3') straight with door | DV-FD536BLK | DV-FD536BL | DV-FD536GR | DV-FD536IV |
| 90° bend without door | DV-FE590BLK | DV-FE590BL | DV-FE590GR | DV-FE590IV |
| 135° bend without door | DV-FE545BLK | DV-FE545BL | DV-FE545GR | DV-FE545IV |
| 150° bend without door | DV-FE530BLK | DV-FE530BL | DV-FE530GR | DV-FE530IV |
| 90° bend with door | DV-FED590BLK | DV-FED590BL | DV-FED590GR | DV-FED590IV |
| 135° bend with door | DV-FED545BLK | DV-FED545BL | DV-FED545GR | DV-FED545IV |
| 150° bend with door | DV-FED530BLK | DV-FED530BL | DV-FED530GR | DV-FED530IV |
| Tee + end cap | DV-FT5BLK | - | - | - |
| 125mm - 150mm increaser | DV-F5-6INCBK | - | - | - |

| | BLACK ENAMEL | MIDNIGHT BLUE ENAMEL | FOREST GREEN ENAMEL | IVORY ENAMEL |
|----------------------------------|--------------|----------------------|---------------------|--------------|
| 152mm diameter | | | | |
| 305mm (1') straight without door | DV-F612BLK | DV-F612BL | DV-F612GR | DV-F612IV |
| 610mm (2') straight without door | DV-F624BLK | DV-F624BL | DV-F624GR | DV-F624IV |
| 915mm (3') straight without door | DV-F636BLK | DV-F636BL | DV-F636GR | DV-F636IV |
| 305mm (1') straight with door | DV-FD612BLK | DV-FD612BL | DV-FD612GR | DV-FD612IV |
| 610mm (2') straight with door | DV-FD624BLK | DV-FD624BL | DV-FD624GR | DV-FD624IV |
| 915mm (3') straight with door | DV-FD636BLK | DV-FD636BL | DV-FD636GR | DV-FD636IV |
| 90° bend without door | DV-FE690BLK | DV-FE690BL | DV-FE690GR | DV-FE690BL |
| 135° bend without door | DV-FE645BLK | DV-FE645BL | DV-FE645GR | DV-FE645BL |
| 150° bend without door | DV-FE630BLK | DV-FE630BL | DV-FE630GR | DV-FE630BL |
| 90° bend with door | DV-FED690BLK | DV-FED690BL | DV-FED690GR | DV-FED690BL |
| 135° bend with door | DV-FED645BLK | DV-FED645BL | DV-FED645GR | DV-FED645BL |
| 150° bend with door | DV-FED630BLK | DV-FED630BL | DV-FED630GR | DV-FED630BL |

C

To help you get the best performance from your stove and keep it in good condition; inside and out; Stovax)Dovre s distributor in the UK and Republic of Ireland offers a wide range of cleaning and maintenance products: Stovax also supply a wide variety of replace accessories: Your Dovre retailer will be able to give you full details or you may view the complete range at :

P I G

Dovre reserves the right to amend any specifications herein or to make any product design changes: Please note that; due to studio lighting and the limitations of the printing process; colour reproduction of enamel finishes may vary from actual product: Please consult your Dovre retailer for more accurate colours:

Dovre products are guaranteed for two years from the date of purchase; with cast parts enjoying a five year guarantee: This guarantee excludes labour and all wearing parts such as glass and refractory bricks in the case of woodburning-multi fuel stoves and thermocouples or lamps in the case of gas or electric stoves:

DIMENSIONS

CORRECT INSTALLATION

A HETAS approved installer should undertake a site survey prior to purchase and must install any Dovre stove or fireplace: Your Dovre retailer will be able to advise on this: You may view/download complete installation instructions from our website www.dovre.co.uk

p4/5 | 250 WOOD & MULTI-FUEL STOVES

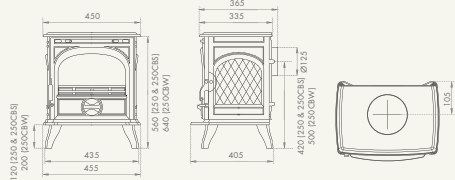

p12/13 | 425 GAS STOVES

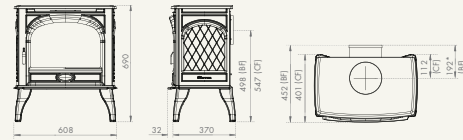

p18/19 | 500 ELECTRIC STOVES

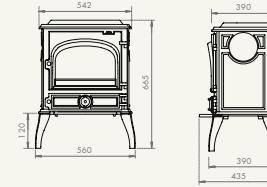

p26/27 | 760CB WOOD STOVE

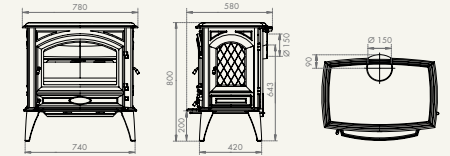

p6/7 | 280 GAS STOVES

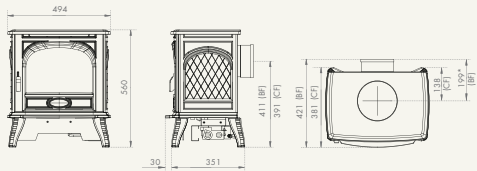

p14/15 | 425 ELECTRIC STOVES

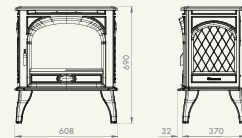

p20/21 | 555 MULTI-FUEL STOVE

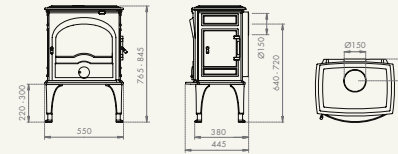

p28/29 | ASTROLINE 1CB WOOD STOVE

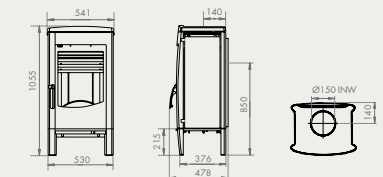

p8/9 | 280 ELECTRIC STOVES

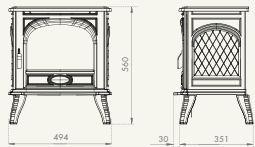

p16/17 | 500 MULTI-FUEL STOVES

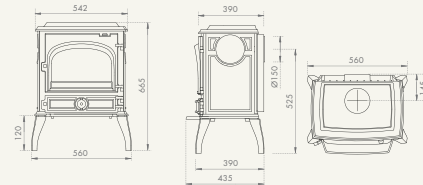

p22/23 | 640CB WOOD STOVE

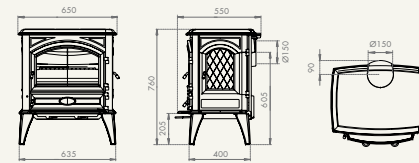

p30/31 | ASTROLINE 2CB WOOD STOVE

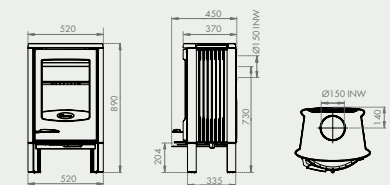

p10/11 | 425 MULTI-FUEL STOVES

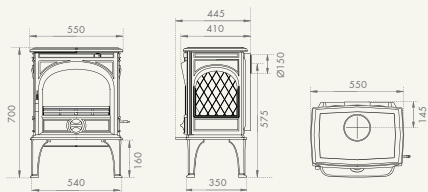

p24/25 | 700 MULTI-FUEL & WOOD STOVES

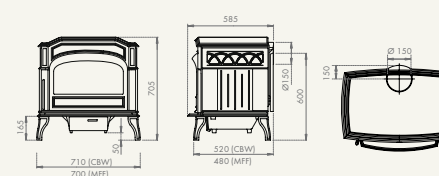

p32/33 | ASTROLINE 3CB MULTI-FUEL & WOOD STOVES

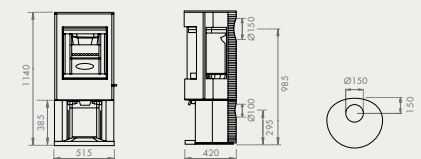

*To end of rear flue spigot. Full installation instructions with information on balanced flue configurations are available from www.dovre.co.uk

*To end of rear flue spigot. Full installation instructions with information on balanced flue configurations are available from www.dovre.co.uk

DIMENSIONS

CORRECT INSTALLATION

A HETAS approved installer should undertake a site survey prior to purchase and must install any Dovre stove or fireplace: Your Dovre retailer will be able to advise on this: You may view/download complete installation instructions from our website www.dovre.co.uk

p34/35 | ASTROLINE 4CB MULTI-FUEL & WOOD STOVES

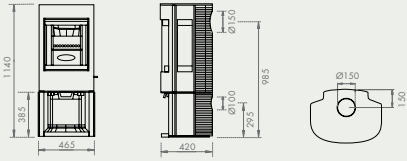

p38/39 | ASTROLINE 360CB/3 WOOD STOVE

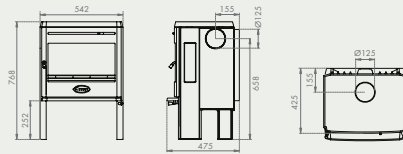

p46/47 | 2000 FIREPLACE*

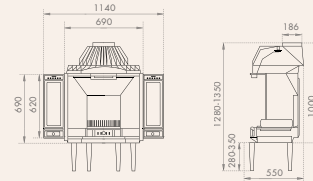

p54/55 | 2900 FIREPLACE*

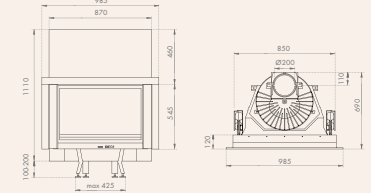

p36/37 | ASTROLINE 350CB WOOD STOVE

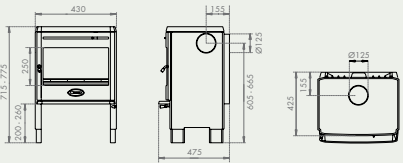

p40/41 | 2510 DOUBLE-SIDED CASSETTE FIRE

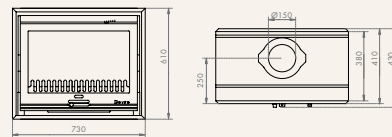

p48/49 | 2300CB FIREPLACE*

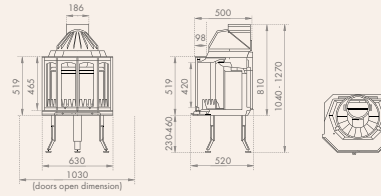

p56/57 | 1800 GAS FIREPLACE*

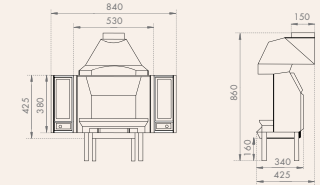

p36/37 | ASTROLINE 350CB/3 WOOD STOVE

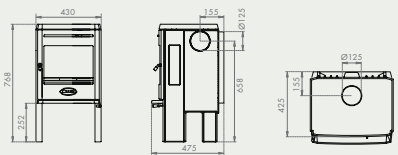

p42/43 | 2520 CASSETTE FIRE

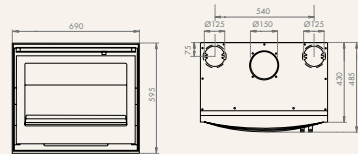

p50/51 | 2400CB FIREPLACE*

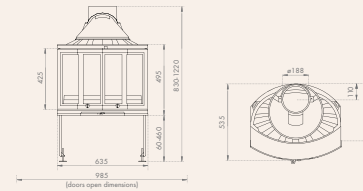

p58/59 | 2700 GAS FIREPLACE*

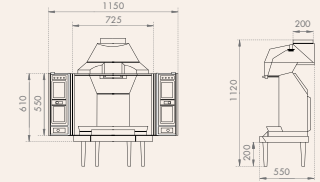

p38/39 | ASTROLINE 360CB WOOD STOVE

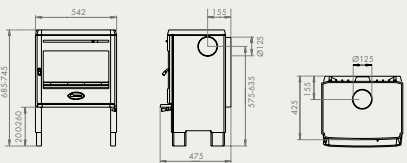

p44/45 | 1800 FIREPLACE*

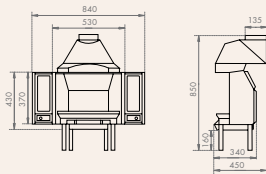

p52/53 | 2700 FIREPLACE*

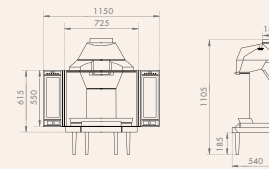

* Legs shown on these models are for use only when building the appliance into a fireplace. They are not intended for freestanding applications such as inglenooks.