

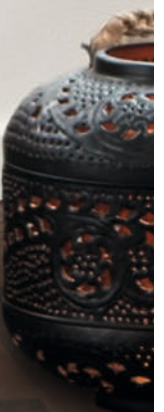

We make it easy to do it right

Wood burning stoves & Accessories

2017-2018



All Aduro wood burning stoves are Nordic Eco-Label certified

"One should feel the beauty of a bonfire in the living room."

Casper Storm, Designer



Clean combustion – reduce smoke in the neighbourhood

More heat for your home thanks to natural convection

Effective air wash system to prevent soot on the glass

Spare parts available online on aduroshop.com

High quality, reliable products

Easy to use

Get the most out of your firewood with the innovative Aduro-tronic, Aduro Smart Response and Aduro DraftOptimizer

Elegant Danish design

Free warranty extension, enjoy up to 5 years warranty

A complete range of solutions to enjoy the natural heat of firewood

We make it easy to do it right

More than 300.000 stove owners throughout Europe have chosen Aduro to warm their homes. We can provide you with a complete package, from firelighters and stoves to chimneys and smoke exhauster.

With elegant Scandinavian design and more than 25 models to suit your home (of which 14 are suitable for use in smokeless areas), you'll be spoilt for choice.

All Aduro stoves are designed with usability and sustainability in mind. The innovation of Aduro goes well beyond the stoves: we listen to our customers to develop and enrich our range with new solutions to get the most out of your firewood. Burn better and save your money thanks to the exclusive Aduro-tronic. For any kind of chimney, Aduro DraftOptimizer will improve the draft and make it easier to light up the stove. Our intelligent thermometer Aduro Smart Response brings the secret to a perfect combustion on your phone.

With Aduro, the best technology for domestic heating is quite simply designed to make it easy to fire correctly and make the most of your wood burning stove.

Rediscover the natural heat of firewood and let Aduro guide you in a world of INNOVATION, WARMTH and COMFORT.

Customer testimonials

On Aduro-tronic

"Compared to our previous stove we can really feel the difference. Lighting is easy and we have reduced our firewood use massively"

Bodil Pedersen

On Aduro DraftOptimizer

"We used to have problems with smoke in the living room, sooty glass and trouble lighting up the stove. Now I can enjoy the warmth, light and sound from my wood burning stove"

Palle Nielsen

On Aduro Smart Response

"I always thought I was using my stove correctly, but now I can see that the temperatures at which I was burning were much too high. At the same time it is really smart that it lets you know when it is time to add more firewood"

Preben Brøchner

On Aduro DraftOptimizer

"Now, we are done with missing draught in the chimney and smoke coming out in to our living room. It is easily controlled with a small remote. And I also think that the neighbors are smiling a little more"

Anne Hasselholm



The secret to perfect combustion in your pocket

Now, your phone can tell you, when to add more firewood.

We have made an app that helps you use your wood burning stove optimally. The intelligent thermometer, Aduro Smart Response, tells you when to add firewood, what your wood burning stove's temperature is and whether the burn temperature is too high or too low. It can save you a lot.

With Aduro Smart Response you save time, money and energy by using your wood burning stove correctly. Aduro Smart Response works with all wood burning stoves regardless of brand and model.

Read more at adurofire.com

-  Improves combustion
-  Less smoke out of the chimney
-  Reduces firewood usage

Burn wisely Save up to 40%

The recipe is simple. Load your wood, light up and let the patented Aduro-tronic Automatic take over. The device automatically regulates the air supply to ensure optimal combustion. This means that you enjoy simple operation, clean combustion and up to 40% less wood consumption. That is as easy as it gets.

The automatic device is smartly integrated below the combustion chamber and works without electricity. All Aduro wood burning stoves are equipped with Aduro-tronic as a standard.

On adurofire.com, you can watch a video showing how it works.



Automatic air supply
up to 40%
less wood consumption

Aduro Tronic



Aduro stoves with external air supply

AIR

Wood burning stoves need a constant air supply to ensure clean and effective combustion. However, this can be a problem in modern, energy-efficient homes, which are often very airtight. **Aduro 9 air, 9.3 Lux, 9.5 Lux, 12 and 13.1** are therefore fitted with external air supply, meaning air for combustion is brought from the outside and seamlessly led directly into the stove without affecting its appearance.

Did you know?

Aduro offers a complete kit for installation of the fresh air system. The kit includes all the components necessary for a standard rear facing installation.

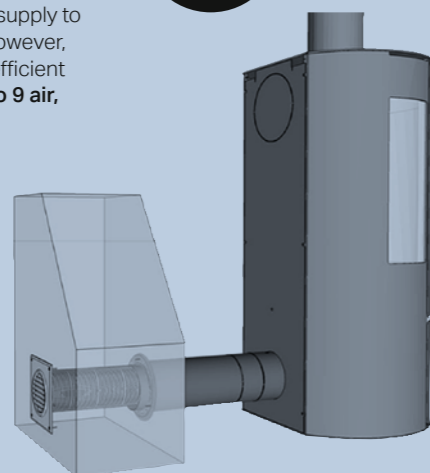

Defra approved

Danes are particularly proud of their environmental commitment and Aduro leads the way as the only wood burner manufacturer in the world with a full range of Nordic Ecolabel wood burning stoves. We offer a wide range of Defra approved wood burning stoves for use in smokeless areas.



Aduro & the environment



Advanced combustion principles and a continuous effort to minimise impact on the environment are at the core of every Aduro wood burning stove. This is why our stoves are made to meet the world's most stringent environmental standards, including the Nordic Eco-Label.

The Nordic Eco-Label is your guarantee that the product is among the most environmentally friendly on the market, and that it meets the highest requirements on efficiency and clean combustion. All Aduro wood burning stoves exceed Nordic Eco-Label requirements and are among the very best in the world thanks to low emissions and limited smoke output. This is something of which we are very proud. Read more about emissions and efficiency at the end of this catalogue.

Extras, tips & tricks

Visit tips.adurofire.com for tips & tricks for lighting and firing, information on burning and advice and guidance on using your wood burning stove. You can also register as a user and receive news, extras and discounts.

tips.adurofire.com

5-year warranty

You can safely use your new Aduro wood burning stove. Register your stove on adurofire.com/warranty within five months after the purchase and enjoy a free five year warranty.

adurofire.com/warranty

"With the Aduro 9 Lux series, we took the popular Aduro 9 series a step further. I wanted to create a more exclusive series characterised by a black glass door, newly developed handles and an exclusive closing mechanism. The big curved glass door catches the eye with its polished and glossy look while the handles' discreet appearance leaves you with a direct view of the flames."

Designer, Casper Storm



Aduro 9 Lux series



Aduro 9.3 Lux

The slender pedestal raises the combustion chamber and adds a lightness to the wood burning stove. It's simply elegant and light in its expression.



Heats 30-140 m² • 6 kW • Flue outlet top/rear
Dimensions (HxWxD) 114 x 50 x 45.8 cm



Aduro 9.5 Lux

The streamlined and elegant exterior of the Aduro 9.5 Lux combined with the height - 120 cm - makes this stove special. Aduro 9.5 Lux will look beautiful in big rooms with high ceilings. It's characterised by its big storage compartment with a door and the raised combustion chamber which makes it easier to use.



Heats 30-140 m² • 6 kW • Flue outlet top/rear
Dimensions (HxWxD) 120 x 50 x 45.8 cm

Decoration

Decorate your wood burning stove with an attractive top plate in sandstone or soapstone (Serpentino). Fits all models in the Aduro 9 and Aduro 9 Lux series.



Sandstone top plate

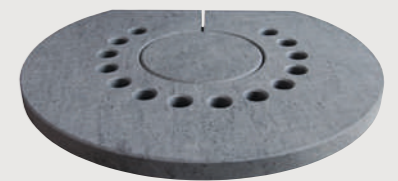

Soapstone top plate (Serpentino)



Stainless steel handle



Easy assembly with cast iron pipe outlet



Elegant black glass door

Aduro 9 series



"When we were developing the Aduro 9 series one of my specific goals was to achieve a stove with the largest possible glass area. One should feel the beauty of a bonfire in the living room. Our efficient air-wash system prevents soot from accumulating on the glass, since a clear view into the living fire was an important factor. Another aim was to create an attractive interior to the combustion chamber, so we have designed the insulation plates with a relief to highlight the vertical lines and the height of the combustion chamber. You will find the signature of Scandinavian design in any model from the Aduro 9 series."

Casper Storm, Designer



Aduro 9 & 9 air

The side-view glass makes the experience of the living flame entirely unique on this model with a 180-degree view of the fire.

External air supply

The Aduro 9 is also available in a variation with external air supply, meaning air for combustion can be brought from outside and led directly into the stove. The actual air intake is concealed by installing it behind or below the stove.



Heats 30-140 m² • 6 kW • Flue outlet top/rear
Dimensions (HxWxD) 95.8 x 50 x 44.7 cm



Aduro 9.3

The pedestal raises the combustion chamber making the flames the focal point. It adds a point of sculptural interest to any room.



Heats 30-140 m² • 6 kW • Flue outlet top/rear
Dimensions (HxWxD) 104 x 50 x 49 cm

Aduro 9.1

The characteristic round design surrounds the fire and invites one's gaze right into the flame. Same dimensions and profile as the Aduro 9, but without side-view glass.



Heats 30-140 m² • 6 kW • Flue outlet top/rear
Dimensions (HxWxD) 95.8 x 50 x 44.7 cm



Accessories



Half-moon glass floor hearth
For the Aduro 9 and Aduro 9 Lux series, we have created a special glass floor hearth with a detachable front, shaped to elegantly fit the stove's contour.



Stainless steel handle



Moulded vermiculite in the combustion chamber



Easy assembly with cast iron pipe outlet



Extra-large ash pan



Aduro 9.7

The tallest Aduro wood burning stove, the Aduro 9.7 stands up at 150 cm like a column in the room. Within the top, a 58 kg heat-absorbent stone is hidden. Another characteristic feature of this model is the large storage compartment below the combustion chamber for storing firewood and the fine base detailing.



Heats 30-140 m² • 6 kW • Flue outlet top/rear
Dimensions (HxWxD) 150 x 50 x 44.7 cm



Heat-absorbent stone

Aduro 9.5

With the Aduro 9.5, the aim was to create a tall stove – 120 cm – with a raised combustion chamber. This makes it easier to operate and provides a perfect view in to the flames. The Aduro 9.5 will look great in large rooms with high ceilings. The stove comes with a large storage compartment with a door.



Heats 30-140 m² • 6 kW • Flue outlet top/rear
Dimensions (HxWxD) 120 x 50 x 44.7 cm



Aduro 9.4

The wall mounted Aduro 9.4 wood burning stove emphasises the vision of the flame, creating a beautiful illusion of a floating fire in your home.



Heats 30-140 m² • 6 kW • Flue outlet top/rear
Dimensions (HxWxD) 75.2 x 50 x 46 cm



Adjustable power output



Integrated cast iron handle

Aduro 18

Elegant and sturdy wood burning stove in cast iron with a wide flame image. Our choice of cast iron was straight forward, because it has a beautiful coarse-grained surface and provides unique possibilities of casting beautiful details and curves.

Aduro 18 has a door underneath the combustion chamber, which easily tilts out to offer space for fireplace accessories.



Heats 30-140 m² • 6.5 kW • Flue outlet top/rear
Dimensions (HxWxD) 99.4 x 77.1 x 38.5 cm



Aduro 15 series

"The primary goal when creating the Aduro 15 series has been to produce a stove with a very wide combustion chamber that can accommodate logs up to 50 cm in length. The elegant elliptical section was an obvious way to widen the shape while maintaining a minimal depth at the same time. This has given the stove a very elegant appearance. Nothing disrupts the broad view of the fire, as handles and levers for air control are fully integrated into the stove."

Casper Storm, Designer



Aduro 15

A distinguishing characteristic of the Aduro 15 is the door below the combustion chamber, which easily tilts out to offer space for fireplace accessories.



Heats 30-140 m² • 6.5 kW
Flue outlet top/rear
Dimensions (HxWxD) 84 x 77.9 x 36.6 cm



Aduro 15.3

The broad shape combined with minimal depth gives this wall-mounted model a truly elegant look.



Heats 30-140 m² • 6.5 kW • Flue outlet top/rear
Dimensions (HxWxD) 62.8 x 77.9 x 36.6 cm



Aduro 15.1

The elliptical shape is underlined even further on the Aduro 15.1, clearly visible at the base of the stove. At the same time, the combustion chamber seems nearly to float because of the light and open look.



Heats 30-140 m² • 6.5 kW
Flue outlet top/rear
Dimensions (HxWxD) 79.5 x 77.9 x 36.6 cm

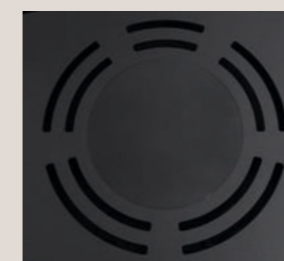

Stylishly integrated convection vents



Moulded vermiculite in the combustion chamber



Aduro key for stove operation is included



Integrated stainless steel handle



Auro 15SK Limestone

Auro 15SK Limestone is clad with limestone on the sides and top. The white stones give an elegant and exclusive look to the stove.



Heats 30-140 m² • 6.5 kW
Flue outlet top/rear
Dimensions (HxWxD) 86.4 x 78.3 x 36.6 cm



Auro 15SK

Auro 15SK is clad with soapstone on the sides and top. Soapstone is a natural product that absorbs heat and releases it gradually over time, and each stone has unique colouring and structure. Decorative and functional at the same time. The door underneath the combustion chamber is easily opened.



Heats 30-140 m² • 6.5 kW • Flue outlet top/rear
Dimensions (HxWxD) 86.4 x 78.3 x 36.6 cm

Accessories



Elliptical glass floor hearth
For the Auro 15 series, we have created a detachable glass floor hearth, shaped to elegantly fit the stove's contour (except Auro 15.1 and 15.3).



Auro 12

Cubistic wood burning stove with large corner glass allowing great visibility from multiple angles. The Auro 12 is the ideal corner model, as the flue pipe can be angled to either side. This model comes with an additional module for firewood storage: the Auro wood rack. The modular wood rack is designed to blend perfectly with the Auro 12, creating a unique and fully integrated stove that will fit perfectly against a straight wall.



Heats 30-140 m² • 6 kW • Flue outlet top/rear
Dimensions (HxWxD) 101.5 x 41.8 x 41.8 / 101.5 x 67.8 x 41.8 cm



Integrated stainless steel handle



Top plate in add-on module

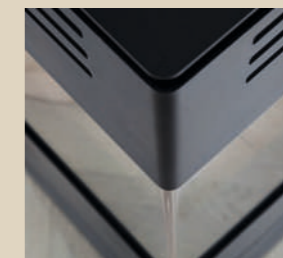

Corner glass



Storage compartment

Aduro 1.1 series



"With the Aduro 1.1 series, I tried to create a natural extension of the fireplace – so I took the cylinder and cut details into it. To underline this I decided to leave the front completely flat - the door handle and the airflow adjustment handle are fully integrated into the stove, giving it an attractive and elegant look. The stove has a large curved glass that allows a clear view into the flames. With the Aduro 1.1 series I feel that I have succeeded in creating a gathering point around the fire that takes both environment and user experience into consideration."

Casper Storm, Designer



Aduro 1.1SK

The Aduro 1.1SK is clad with soapstone on the sides and top. Soapstone is a natural product that absorbs heat and releases it gradually over time, and each stone has unique colouring and structure. Decorative and functional at the same time.



Heats 30-140 m² • 6 kW • Flue outlet top/rear
Dimensions (HxWxD) 104.5 x 50 x 45 cm



Aduro 1.1

The Aduro 1.1 is the embodiment of cosy, crackling warmth, and its clean lines will fit into any home. The stove features a drawer for storage of fireplace accessories etc.



Heats 30-140 m² • 6 kW • Flue outlet top/rear
Dimensions (HxWxD) 101.5 x 50 x 45 cm

Aduro 1.1SK Limestone

Aduro 1.1SK Limestone is clad with limestone on the sides and top. The white stones give an elegant and exclusive look to the stove.



Heats 30-140 m² • 6 kW • Flue outlet top/rear
Dimensions (HxWxD) 104.5 x 50 x 45 cm



Aduro 1.2

The Aduro 1.2 differs from the other stoves in the series in that it has a firewood compartment to store wood.



Heats 30-140 m² • 6 kW • Flue outlet top
Dimensions (HxWxD) 90 x 50 x 45 cm

Accessories

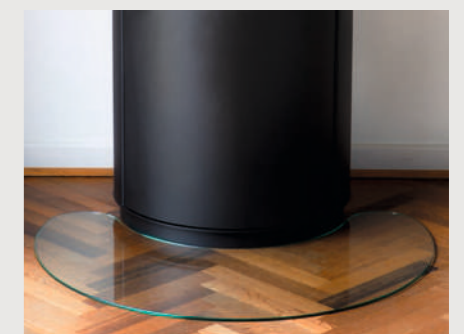

Half-moon glass floor hearth
For the Aduro 1.1 series, we have created a special glass floor hearth with a detachable front, shaped to elegantly fit the stove's contour.



Aduro 13 series is an unique series, where everything from the body to the handle is produced from cast iron, with a raw and rustic surface. The stove has side-view glass and is an ideal fit in tighter spaces because of its reduced depth.



Aduro 7.2

Aduro 7.2 is a stylish, elegant and harmonious stove with a Scandinavian look. Fine details include the integrated handles and lightly curved front. The stove has a storage compartment with a door.

-  **Aduro Tronic**
-  **up to 40% less wood consumption**

Heats 30-140 m² • 7 kW • Flue outlet top/rear
Dimensions (HxWxD) 105.8 x 49.7 x 43.4 cm



Aduro 13.1

The large storage compartment below the combustion chamber, external air supply and additional height are key features of the Aduro 13.1.

-  **Aduro Tronic**
-  **up to 40% less wood consumption**
-  **AIR**

Heats 30-120 m² • 5 kW • Flue outlet top/rear
Dimensions (HxWxD) 97 x 48 x 34.5 cm



Aduro 13

The almost floating combustion chamber gives the Aduro 13 a light and elegant look. Cast iron also allows for soft curves and fine detailing.

-  **Aduro Tronic**
-  **up to 40% less wood consumption**

Heats 30-120 m² • 5 kW • Flue outlet top/rear
Dimensions (HxWxD) 87 x 48 x 34.5 cm



Moulded vermiculite in the combustion chamber



Aduro key for stove operation is included



Integrated stainless steel handle



Integrated cast iron handle



Stylishly integrated convection vents



Auro 5.1

Cleanly styled fireplace insert with a completely flat front and large glass door, allowing a wonderful view of the fire. The handles are cleanly integrated, giving the impression of a completely flat surface. The combustion chamber is insulated with moulded vermiculite to match the stove's clean and minimalist design. Can be built into both existing and new fireplaces.

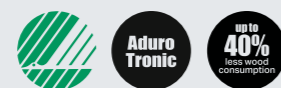

Heats 30-140 m² • 7 kW
Flue outlet top/rear
Dimensions (HxWxD) 57.4 x 63.5 x 46 cm

Auro 16

The Auro 16 makes it possible to turn an old fireplace into an environmentally friendly and efficient heat source.

Heats 30-120 m² • 5 kW
Flue outlet top/rear
Dimensions (HxWxD) 56.4 x 46.2 x 41.9 cm



Auro 14

Auro 14 combines sheet iron and cast iron in a simple and sharply cubist design. Sheet iron is ideal for the smooth surfaces and sharp corners, forming a striking contrast to the sturdy, rustic cast iron door. The stringent but harmonious expression is completed by the integrated roomy storage compartment, which is the perfect place to keep fire irons.

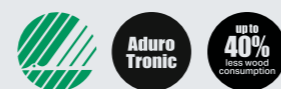

Heats 30-140 m² • 6.5 kW • Flue outlet top
Dimensions (HxWxD) 90 x 51.1 x 37 cm



Auro Prisma Pizza Oven

Do you dream of serving homemade pizzas with a taste of Italy for your friends and family? Then Auro Prisma Pizza Oven is the answer. Auro Prisma is also the perfect place to gather around the fire. It's also possible to buy Auro Prisma Base which lifts up the pizza oven from the ground. At the same time, you can store firewood in a decorative way.

The pizza oven is made out of 3 mm Corten steel which will gain a nice rust coloured patina from exposure to rain, sun and wind.

Dimensions (HxWxD) 69.7 x 72 x 72 cm
Dimensions Base (HxWxD) 59.3 x 71.3 x 71.3 cm



Auro Outdoor Fireplace

Enjoy a delightful barbecue over natural wood coals or just let yourself be seduced by the flickering fire out on the terrace. Auro's outdoor fireplace is made from 3 mm Corten steel, which after a short time of use will begin to take on a beautiful rust-coloured patina from exposure to the rain, sun and wind. Grill rack available as an accessory.

Dimensions (HxWxD) 124 x 60 x 58 cm

See more on adurofire.com

Accessories

We have designed a series of accessories to complete the experience of a living flame, both aesthetically and functionally. Our accessory line was created with special attention to achieving perfect function and easy operation.



Firewood baskets

Firewood baskets in felt, imitation leather and PET can be used to store not only wood, but also newspapers, magazines and children's toys. Comfortable handles make the baskets easy to carry.

Aduro Proline Ø45



Aduro Proline in felt, grey



Aduro Proline in PET, black



Aduro Proline in PET, khaki melange



Aduro Proline plastic insert, black
The plastic insert fits perfectly inside the Ø45 baskets. It protects the basket and makes it easy and practical for gathering firewood.

Aduro Proline Ø39



Aduro Proline in PET, black



Aduro Proline in felt, grey



Aduro Proline in imitation leather, black



Aduro firewood bucket, black steel



Aduro Proline briquette box, black steel

Aduro Baseline

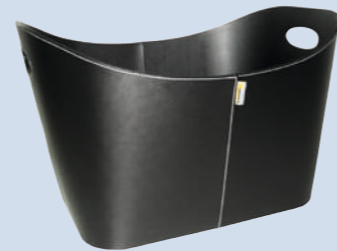

Aduro Baseline in imitation leather, black



Aduro Baseline in PET, black

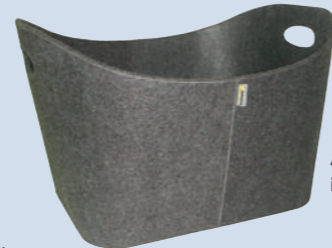

Aduro Baseline in felt, grey

Companion sets

We offer a wide assortment of companion sets in black steel, stainless steel, imitation leather and, our best seller, Aduro Magnetic Tools, a magnetic tool set that's easy to store.



Aduro Proline 1



Aduro Baseline 1



Aduro Proline 2



Aduro Baseline 2



Aduro Proline 3



Aduro Magnetic Tools



Ash shovel



Ash poker

Lighting up

Enjoy fast, safe and odourless lighting in your wood burning stove with Aduro's lighting products. Try Aduro Easy Firelighter, Bio-wool, which with a single match stroke will create crackling comfort - and it's even environmentally friendly.

With Aduro Wood Moisture Meter you can rapidly measure the moisture level of your wood, whilst Aduro Smart Response will connect your smartphone to the stove and guide you towards perfect combustion.



Aduro Easy Firelighter, Bio-wool



Aduro Easy Firelighter, Bio-cube



Aduro Easy Firelighter, Bio-stick



Aduro Easy Firelighter, Bag



Aduro Wood Moisture Meter



Aduro Smart Response

Safety

No matter which wood burning stove you have chosen, we have a floor hearth to fit. Aduro offers a wide selection of glass and steel hearths as well as a special floor hearth for the Aduro 1.1, Aduro 9, Aduro 9 Lux and Aduro 15 series. The glass floor hearths are made from 6 mm tempered clear glass with polished c-edges, while the steel floor hearths are made from 1.5 mm black high-grade steel. Take note of local/national requirements regarding distance to combustible materials.

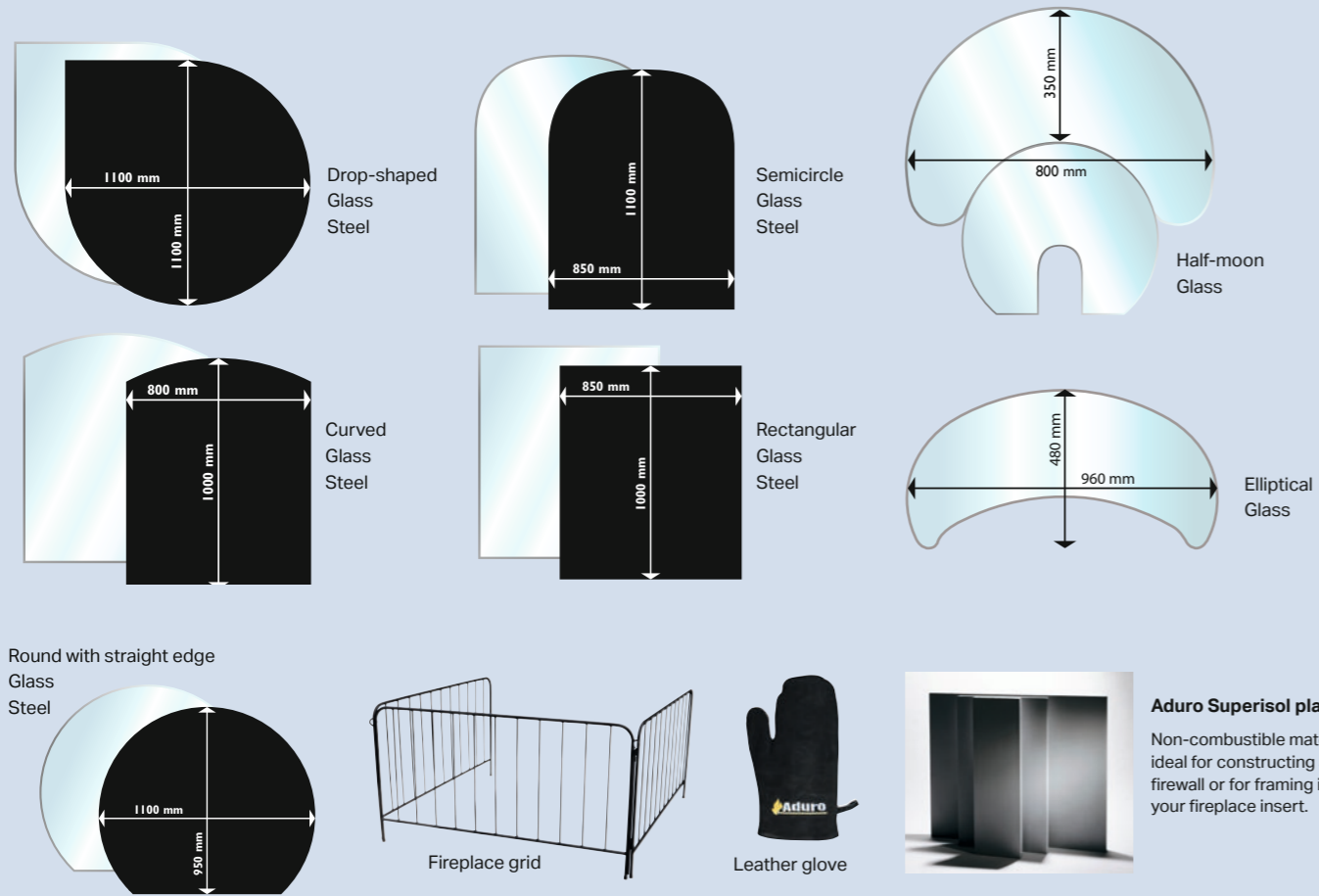

Aduro Superisol plates
Non-combustible material ideal for constructing a firewall or for framing in your fireplace insert.

Maintenance

Safe use of your wood burning stove requires routine maintenance. Here you will find all the products you need to extend the lifetime of your stove.

Aduro Easy Clean

The perfect pad for cleaning the glass in your wood burning stove. The pad will not scratch or damage the surface of the glass and can be used several times.



Aduro Easy Clean

Aduro Proline ash bucket, black steel

Aduro DraftOptimizer

The chimney is the engine of the wood burning stove and it powers combustion. Some experience problems with combustion because of bad draft in the chimney. Aduro DraftOptimizer ensures constant, even draft and reduces smoke and smell. It's installed on top of the chimney and controlled from the inside of the house.

Aduro DraftOptimizer fits both old and new chimneys.

- LESS SMOKE OUT OF THE STOVE DOOR**
- IMPROVES COMBUSTION – ADJUSTABLE DRAFT**
- LESS SMOKE OUT OF THE CHIMNEY**
- EASY LIGHTING OF YOUR STOVE**
- 24 VDC LOW VOLTAGE EC ENGINE**
- MADE OF STAINLESS STEEL GRADE AISI 304**



Flue pipes

Aduro offers a versatile range of flue pipes with colours matched to the stove models. The pipes are made from 2 mm high-grade steel, Ø150 mm.

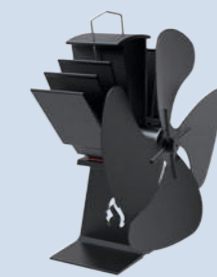

Aduro Stove Fan

Place the Aduro Stove Fan directly on top of your wood burning stove and optimise heat distribution throughout your home. No electricity required.

Aduro Fresh Air Kit, Ø80 mm

Complete kit for installation of the fresh air system. The kit includes all the components necessary for a standard rear-facing installation.

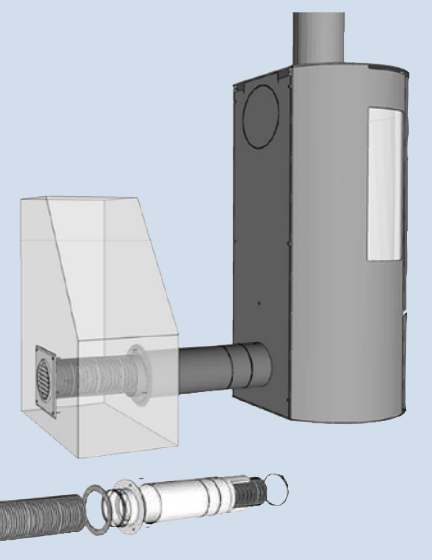

Specifications

In the following, you will find specifications for each individual stove. Make sure to read the user manual carefully before installing your new Aduro wood burning stove, and take note of applicable laws and regulations.



	Aduro 1.1	Aduro 1.1SK	Aduro 1.1SK Limestone	Aduro 1.2	Aduro 5.1	Aduro 7.2	Aduro 9	Aduro 9 Air	Aduro 9.1	Aduro 9.3	Aduro 9.3 Lux	Aduro 9.4	Aduro 9.5	Aduro 9.5 Lux	Aduro 9.7	Aduro 12	Aduro 13	Aduro 13.1	Aduro 14	Aduro 15	Aduro 15.1	Aduro 15.3	Aduro 15SK	Aduro 15SK Limestone	Aduro 16	Aduro 18	
Article number	50215	50315	50316	50115	50453	50273	50291	50296	50292	50294	50301	50295	50299	50302	50300	50523	50535	50534	50541	50551	50552	50554	50556	50557	50561	50581	
Nominal power	6 kW	6 kW	6 kW	6 kW	7 kW	7 kW	6 kW	6 kW	6 kW	6 kW	6 kW	6 kW	6 kW	6 kW	6 kW	6 kW	5 kW	5 kW	6.5 kW	6.5 kW	6.5 kW	6.5 kW	6.5 kW	6.5 kW	5 kW	6.5 kW	
Operational area	3-9 kW	3-9 kW	3-9 kW	3-9 kW	3-9 kW	3-9 kW	3-9 kW	3-9 kW	3-9 kW	3-9 kW	3-9 kW	3-9 kW	3-9 kW	3-9 kW	3-9 kW	3-9 kW	2-7 kW	2-7 kW	3-9 kW	3-9 kW	3-9 kW	3-9 kW	3-9 kW	3-9 kW	2-7 kW	3-9 kW	
Heats	30-140 m ²	30-140 m ²	30-140 m ²	30-140 m ²	30-140 m ²	30-140 m ²	30-140 m ²	30-140 m ²	30-140 m ²	30-140 m ²	30-140 m ²	30-140 m ²	30-140 m ²	30-140 m ²	30-140 m ²	30-140 m ²	30-120 m ²	30-120 m ²	30-140 m ²	30-140 m ²	30-140 m ²	30-140 m ²	30-140 m ²	30-140 m ²	30-120 m ²	30-140 m ²	
Dimensions in cm																											
Flue outlet, diameter	Ø15 top/ rear	Ø15 top/ rear	Ø15 top/ rear	Ø15 top	Ø15 top/ rear	Ø15 top/ rear	Ø15 top/ rear	Ø15 top/ rear	Ø15 top/ rear	Ø15 top/ rear	Ø15 top/ rear	Ø15 top/ rear	Ø15 top/ rear	Ø15 top/ rear	Ø15 top/ rear	Ø15 top/ rear	Ø15 top/ rear	Ø15 top	Ø15 top/ rear	Ø15 top/ rear	Ø15 top/ rear	Ø15 top/ rear	Ø15 top/ rear	Ø15 top/ rear	Ø15 top/ rear	Ø15 top/ rear	Ø15 top/ rear
Outer dimensions (HxWxD)	101.5 x 50 x 45	104.5 x 50 x 45	104.5 x 50 x 45	90 x 50 x 45	57.4 x 63.5 x 46	105.8 x 49.7 x 43.4	95.8 x 50 x 44.7	95.8 x 50 x 44.7	95.8 x 50 x 44.7	104 x 50 x 49	114 x 50 x 45.8	75.2 x 50 x 46	120 x 50 x 44.7	120 x 50 x 45.8	150 x 50 x 44.7	101.5 x 41.8 / 67.8 x 41.8	87 x 48 x 34.5	97 x 48 x 34.5	90 x 51.1 x 37	84 x 77.9 x 36.6	79.5 x 77.9 x 36.6	62.8 x 77.9 x 36.6	86.4 x 78.3 x 36.6	86.4 x 78.3 x 36.6	56.4 x 46.2 x 41.9	99.4 x 77.1 x 38.5	
Distance to combustible material behind the stove	17	17	17	17	25	25	20	15	15	15	15	15	15	15	15	25	21	21	15	20	20	20	20	20	30	22.5	
Distance to combustible material behind the stove with insulated flue pipe	12	12	12	12	-	-	-	10	10	10	10	10	10	10	10	-	9	9	7	12	12	12	12	12	25	15	
Distance to combustible material to the side	45	45	45	45	30	70	70	70	45	70	70	70	70	70	70	25	46	46	25	34/11	34/11	34/11	34/11	34/11	23	35/11	
Distance to combustible material in corner position	30	30	30	30	-	-	-	-	20	-	-	-	-	-	-	25	-	-	8	-	-	-	-	-	13	-	
Distance to furniture	100	100	100	100	110	102.5	80	90	90	90	90	90	90	90	90	80	100	100	100	120	120	120	120	120	107.5	110	
Distance from floor to centre of rear outlet	88.8	88.8	88.8	-	-	92.2	84	84	84	92.2	102.2	min. 63.4 + 28	108.2	108.2	137	91.3	75.7	86.2	-	68.7	64.2	min. 47.5 + 24	68.7	68.7	46.3	85.2	
Distance from centre of exhaust branch to rear edge of stove	19.5	19.5	19.5	19.5	19	19.5	19.3	20.3	19.3	19.3	20.3	20.8	19.3	20.3	19.3	20.9	16	16	18.5	18.5	18.5	20.6	18.5	18.5	10.6	19.1	
Maximum wood length	36	36	36	36	40	39	39	39	39	39	39	39	39	39	39	34	35	35	39	50	50	50	50	50	36	50	
Width of wood chamber	37	37	37	37	41	40	40	40	40	40	40	40	40	40	40	35	39/31	39/31	40	51	51	51	51	51	37	51	
Aduro-tronic automatic	✓	✓	✓	✓	✓	✓	✓	✓	✓	✓	✓	✓	✓	✓	✓	✓	✓	✓	✓	✓	✓	✓	✓	✓	✓	✓	✓
Convection stove	✓	✓	✓	✓	✓	✓	✓	✓	✓	✓	✓	✓	✓	✓	✓	✓	✓	✓	✓	✓	✓	✓	✓	✓	✓	✓	✓
Primary, secondary, and tertiary air supply	✓	✓	✓	✓	✓	✓	✓	✓	✓	✓	✓	✓	✓	✓	✓	✓	✓	✓	✓	✓	✓	✓	✓	✓	✓	✓	✓
Air-wash system	✓	✓	✓	✓	✓	✓	✓	✓	✓	✓	✓	✓	✓	✓	✓	✓	✓	✓	✓	✓	✓	✓	✓	✓	✓	✓	✓
Ash pan	✓	✓	✓	✓	✓	✓	✓	✓	✓	✓	✓	✓	✓	✓	✓	✓	✓	✓	✓	✓	✓	✓	✓	✓	✓	✓	✓
External air supply	-	-	-	-	-	-	-	✓	-	-	✓	-	-	✓	-	✓	-	✓	-	-	-	-	-	-	-	-	-
Efficiency	81.2 %	81.2 %	81.2 %	81.2 %	78.7 %	78 %	81.3 %	81.3 %	81.3 %	81.3 %	81.3 %	81.3 %	81.3 %	81.3 %	81.3 %	82.2 %	80.5 %	80.5 %	80.4 %	78 %	78 %	78 %	78 %	78 %	78 %	78 %	
Particle emission	1.6 g/kg	1.6 g/kg	1.6 g/kg	1.6 g/kg	3.22 g/kg	1.37 g/kg	1.9 g/kg	1.9 g/kg	1.9 g/kg	1.9 g/kg	1.9 g/kg	1.9 g/kg	1.9 g/kg	1.9 g/kg	1.9 g/kg	2.94 g/kg	1.16 g/kg	1.16 g/kg	2.33 g/kg	1.65 g/kg	1.65 g/kg	1.65 g/kg	1.65 g/kg	1.65 g/kg	1.29 g/kg	1.65 g/kg	
Chimney draft	12 Pa	12 Pa	12 Pa	12 Pa	12 Pa	12 Pa	12 Pa	12 Pa	12 Pa	12 Pa	12 Pa	12 Pa	12 Pa	12 Pa	12 Pa	12 Pa	12 Pa	12 Pa	12 Pa	12 Pa	12 Pa	12 Pa	12 Pa	12 Pa	12 Pa	12 Pa	12 Pa
Weight	95 kg	113 kg	113 kg	90 kg	77 kg	95 kg	93 kg	103 kg	100 kg	103 kg	108 kg	88 kg	115 kg	120 kg	169.2 kg	108 kg	80 kg	92 kg	85 kg	89 kg	86 kg	84 kg	114 kg	114 kg	70 kg	150 kg	
Colour	Black	Black	Black	Black	Black	Black	Black	Black	Black	Black	Black	Black	Black	Black	Black	Black	Black	Black	Black	Black	Black	Black	Black	Black	Black	Black	Black
Certifications	Ecolabel, DIN EN13240, CE & NS3058	Ecolabel, DIN EN13240, CE & NS3058	Ecolabel, DIN EN13240, CE & NS3058	Ecolabel, DIN EN13240, CE & NS3058	Ecolabel, DIN EN13240, CE & NS3058	Ecolabel, DIN EN13240, CE & NS3058	Ecolabel, Defra, DIN EN13240, CE & NS3058	Ecolabel, Defra, DIN EN13240, CE & NS3058	Ecolabel, Defra, DIN EN13240, CE & NS3058	Ecolabel, Defra, DIN EN13240, CE & NS3058	Ecolabel, Defra, DIN EN13240, CE & NS3058	Ecolabel, Defra, DIN EN13240, CE & NS3058	Ecolabel, Defra, DIN EN13240, CE & NS3058	Ecolabel, Defra, DIN EN13240, CE & NS3058	Ecolabel, Defra, DIN EN13240, CE & NS3058	Ecolabel, Defra, DIN EN13240, CE & NS3058	Ecolabel, Defra, DIN EN13240, CE & NS3058	Ecolabel, Defra, DIN EN13240, CE & NS3058	Ecolabel, Defra, DIN EN13240, CE & NS3058	Ecolabel, Defra, DIN EN13240, CE & NS3058	Ecolabel, Defra, DIN EN13240, CE & NS3058	Ecolabel, Defra, DIN EN13240, CE & NS3058	Ecolabel, Defra, DIN EN13240, CE & NS3058	Ecolabel, Defra, DIN EN13240, CE & NS3058	Ecolabel, Defra, DIN EN13240, CE & NS3058	Ecolabel, Defra, DIN EN13240, CE & NS3058	





Wood burning stoves & Accessories

2017-2018