



Crystal Fires

Classic & Contemporary Fires

October 2016

A Quality Range
of British Built Fires

Celebrating
26
years
in the trade

MONTANA

in chrome with logs



AND
THE **CONNELLY**
COLLECTION

Celebrating 26 Years in the Trade

In 1990 two brothers, Chris, a gas engineer now with over 30 years of experience and Ian, a skilled sheet metal worker, combined their expertise and opened a retail outlet in Liverpool selling fires made by Ian to be then installed by Chris.

Over the years Crystal Fires have worked with the British Gas Testing House for their product development, approvals and licensing and have gone from strength to strength, winning awards on the way for their original innovative designs.

26 years on Crystal Fires are one of the market leaders due to an extensive range of contemporary and traditional Living Flame gas fires, always with the main focus on build quality and product efficiency. This is demonstrated in abundance with the release of their new glass fronted Manhattan, Miami, Boston and Florida hole in the wall fires.

Directors quote;

“We have gone from retailing in Liverpool out of a small fireplace showroom to manufacturing in an extensive factory overlooking the historic Aintree Racecourse, supplying our fires to retailers nationwide. Fireplace showrooms like to sell our fires because they know that every single Crystal Fire has been designed, manufactured, assembled, tested and packed entirely by ourselves in Great Britain, and that is why we can confidently offer our Five Year Guarantee.”



Ian Connelly
Director



Chris Connelly
Director



Manufactured in Great Britain

Fuel Beds, Flue Types

Pictures shown for reference only, fuel beds may differ in appearance throughout the range.



Coal



Log



Campfire



Pebbles

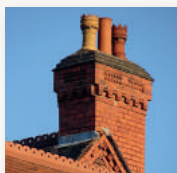

Chimney - Class 1

A conventional brick or stone chimney as used for a solid fuel appliance, with a minimum effective cross section dimension of 225x225 with a minimum of 3m effective height. Or A lined flue with a minimum diameter of 175mm.

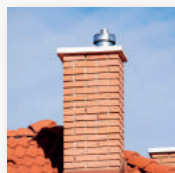

Class 2

A recessed flue box, having a minimum diameter of 125mm and a minimum effective overall height of 3m. Or A brick chamber in an existing brick or stone chimney with a 125mm flue liner providing it is sealed at the top and bottom of the existing stone chimney.

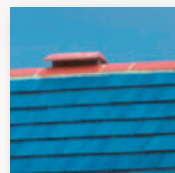

Pre - Cast Flue

A precast flue with a minimum effective height of 3m. Due to the restricted depth of precast flues they are normally suitable for shallow fires.

Example: Diamond, Slimline and Sapphire. To bs1289



Fully Sequential Remote Control

Will switch fire On & off with settings for variable flame height.

Trim Top Control
The trim switch, located on the side of the appliance makes operating your appliance even easier. The fire can also be operated manually, should the need arise.

ODS - Modern gas fires are fitted with an O.D.S. (Oxygen Depletion Sensor). This is designed to shut off the gas supply to the burner in the event of oxygen levels becoming too low, due to a blocked flue or poor ventilation.



THE CONNELLY COLLECTION
Reno
Madison
Tulsa
Denver
Tulsa XL
Page 3 - 16



Florida
Page 17



Montana
Page 29 - 30



Boston
Page 18



Grace
Page 31 - 32



Miami
Page 19



Super Rairdiant
Page 33 - 34



Manhattan
Page 20



Diamond
Page 33 - 34



Gem
Page 21 - 22



Lisa Surround
Page 35 - 36



Option Range
Page 23 - 26



Emerald
Page 35 - 36



Royale
Page 27 - 28



Montana
HE CLASS 1 EFFICIENT
Page 37



Calera Electric Fires
Page 38



Terms & conditions apply

Every care has been taken to ensure the information in this brochure is correct, but should be used as a guide only. slight changes or improvements maybe made, please check with your retailer before purchase.

All dimensions are subject to manufacturing tolerances.



introducing

THE CONNELLY COLLECTION

an exclusive range by Crystal Fires

MADISON

HE CLASS **1** EFFICIENT



NEW

Fire
Interior

**RUSTIC
BRICK**

THE CONNELLY
COLLECTION

RENO
THE CLASS 1 EFFICIENT



RENO with polished trim Aviva front

RENO

THE CONNELLY
COLLECTION

Trim Options		Trim Finish Options	
Trim-less	yes		
3 sided trim	yes	All finishes	
3 sided Royale trim	yes	All finishes	
4 sided trim	yes	All finishes	
Panoramic trim	no		
Grande trim	yes		

Available with cream or black interior.

Gas input (high)	5.5kw
Gas input (low)	2.9kw
Max heat output	4.5kw
Fuel bed	Logs
Fully Remote	Yes
Convected Heat	Yes

HIGH EFFICIENCY RATING OF 82%



NEW
Fire
Interior
**RUSTIC
BRICK**

NEW
Star Black
finish

RENO shown with Grande trim 890mm x 705mm

HE CLASS **1** EFFICIENT



MADISON shown here as a trim-less 'Hole in the Wall' feature

HE CLASS  EFFICIENT

MADISON THE CONNELLY COLLECTION

Trim Options		Trim Finish Options
Trim-less	yes	
3 sided trim	no	
3 sided Royale trim	no	
4 sided trim	yes	All finishes
Panoramic trim	yes	Powder coated finishes only
Grande	yes	

Available with cream or black interior.

Gas input (high)	5.5kw
Gas input (low)	2.9kw
Max heat output	4.5kw
Fuel bed	Logs
Fully Remote	Yes
Convected Heat	Yes

HIGH EFFICIENCY RATING OF 82%



MADISON shown with Grande trim 1000mm x 665mm

HE CLASS **1** EFFICIENT

TULSA

THE CLASS 1 EFFICIENT



THE CONNELLY COLLECTION

THE CLASS **1** EFFICIENT



TULSA pictured here as a trim-less fire in a Limestone fireplace suite

TULSA

THE CONNELLY COLLECTION

Trim Options		Trim Finish Options
Trim-less	yes	
3 sided trim	no	
3 sided Royale trim	no	
4 sided trim	no	
Panoramic trim	no	

Available with cream or black interior.

Gas input (high)	5.5kw
Gas input (low)	2.9kw
Max heat output	4.4kw
Fuel bed	Logs
Fully Remote	Yes
Convected Heat	Yes

HIGH EFFICIENCY RATING OF 80%



DENVER shown with brushed trim 970mm x 490mm

HE CLASS 1 EFFICIENT

DENVER

THE CONNELLY COLLECTION

Trim Options		Trim Finish Options
Trim-less	yes	
3 sided trim	no	
3 sided Royale trim	no	
4 sided trim	yes	All finishes
Panoramic trim	yes	Powder coated finishes only
Grande	yes	

Available with cream or black interior.

Gas input (high)	6.3kw
Gas input (low)	5.1kw
Max heat output	5.1kw
Fuel bed	Logs
Fully Remote	Yes
Convected Heat	Yes

HIGH EFFICIENCY RATING OF 83%



HE CLASS  EFFICIENT

DENVER shown with Black Panoramic trim
1365mm x 590mm



DENVER shown with Grande trim (1150mm x 665mm) & black reflective glass

HE CLASS **1** EFFICIENT



TULSA XL shown here as a trim-less 'Hole in the Wall' feature

HE CLASS **1** EFFICIENT

TULSA XL

THE CONNELLY COLLECTION

Trim Options		Trim Finish Options
Trim-less	yes	
3 sided trim	no	
3 sided Royale trim	no	
4 sided trim	no	
Panoramic trim	no	

Available with cream or black interior.

Gas input (high)	6.3kw
Gas input (low)	2.9kw
Max heat output	5kw
Fuel bed	Logs
Fully Remote	Yes
Convected Heat	Yes

HIGH EFFICIENCY RATING OF 80%

TULSA XL

HE CLASS **1** EFFICIENT



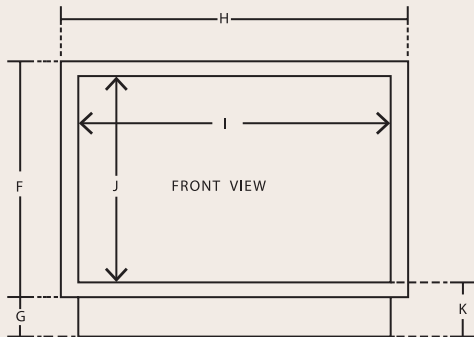
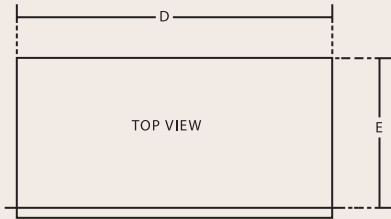
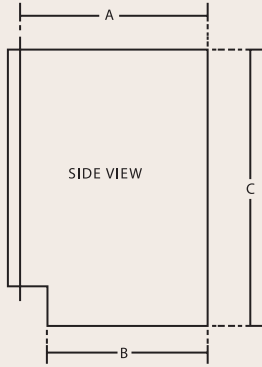

	RENO	MADISON	TULSA	DENVER	TULSA XL
A	305mm	305mm	305mm	305mm	305mm
B	265mm	265mm	265mm	265mm	265mm
C	530mm	530mm	680mm	530mm	780mm
D	580mm	722mm	722mm	872mm	722mm
E	305mm	305mm	305mm	305mm	305mm
F	490mm	490mm	640mm	490mm	740mm
G	80mm	80mm	80mm	80mm	80mm
H	660mm	805mm	805mm	955mm	805mm
I	605mm	750mm	750mm	900mm	750mm
J	410mm	410mm	560mm	410mm	660mm
K	120mm	120mm	120mm	120mm	120mm

BUILDERS OPENING REQUIRED FOR THE FIRE BOX

(ADDITIONAL BUILDING WORK MAY BE REQUIRED TO COMPLETE INSTALLATION)

	RENO	MADISON	TULSA	DENVER	TULSA XL
HEIGHT	550mm	550mm	700mm	550mm	800mm
WIDTH MIN - MAX	605 - 630mm	750 - 775mm	750 - 775mm	905 - 930mm	750 - 775mm
MINIMUM DEPTH	360mm	360mm	360mm	360mm	360mm

FLUE REQUIREMENTS - CLASS 1 OR CLASS 2 (125mm LINER)

ALL MODELS IN THE CONNELLY COLLECTION CAN BE INSTALLED INTO A CONVENTIONAL CLASS 1 CHIMNEY.

IF YOUR CHIMNEY REQUIRES LINING, A 125mm DIAMETER FLUE LINER WITH A MINIMUM LENGTH OF 4 METERS CAN BE USED.

Trim Finishes Available

STAR BLACK
GRAPHITE
STAR BLACK
STAR GRAPHITE

BRONZE/COPPER
CHROME (NOT GRANDE)
BRUSHED (NOT GRANDE)
BLACK

Florida

(With Twin Fan Convector)

The Florida glass fronted gas fire has a unique twin fan convector. The low voltage fans use an insignificant amount of electricity and can be switched on or off via your remote handset. The heat performance & efficiency of the Florida, even without the fans on, is already amongst the best on the market. With the fans on, the Florida is simply unrivalled.



Florida with Black trim and Brushed outer with Logs



Florida with Black trim and pebbles



Florida with Copper trim, Pebbles and Black Brick Interior

Fire Info

Gas Input:	2.9kW - 5.5kW
Heat Output:	Up to 4.2kW
Finish:	Black Texture
	Bronze
	Graphite Grey
	Chrome (outer frame)
	Brushed (outer frame)

Control Options:	Remote
Fuel Options:	Logs
	Pebbles
	Driftwood

Flue Type

Class 1:	Yes
Class 2:	Yes
Precast Flue:	No
ODS:	Yes

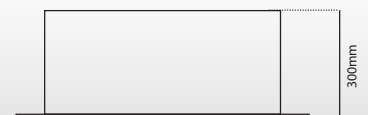
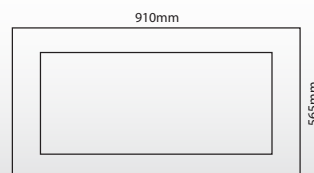
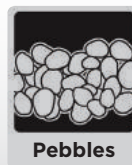
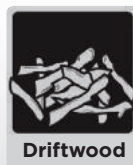

Ideal opening size required:
width 750mm x Height 490mm x Depth 340mm

Boston

The Boston glass fronted gas fire has both style and performance. With a choice of trim finishes, cream or black interior and the option of logs, pebbles or driftwood, this fire is designed to suit any room setting. The Boston has one of the best looking flame patterns on the market and comes with remote control as standard.



Boston with Black trim and Logs



Boston with Copper trim and Logs



Boston with Chrome trim and Pebbles

Fire Info

Gas Input:	2.9kW - 5.5kW
Heat Output:	Up to 4.2kW
Finish:	Black Texture
	Bronze
	Graphite Grey
	Chrome
	Brushed

Control Options: Remote

Fuel Options: Logs
Pebbles
Driftwood

Flue Type

Class 1:	Yes
Class 2:	Yes
Precast Flue:	No
ODS:	Yes

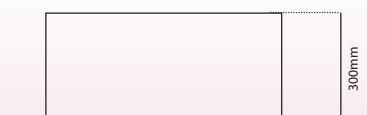
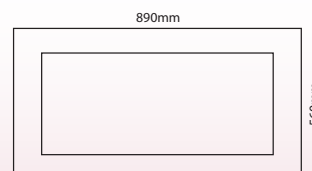
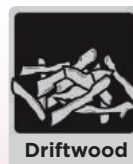

Ideal opening size required:
width 750mm x Height 490mm x Depth 340mm

Miami

This stunning award winning, high efficiency glass fronted fire has a panoramic design and realistic fuel effect, which makes the Miami one of the best looking fires on the market. Available with cream or black interior, we have also added Driftwood to the fuel options



Miami with Copper trim and Black interior



Miami with Grey trim and Black interior

Fire Info

Gas Input:	2.9kW - 5.5kW
Heat Output:	Up to 4.2kW
Finish:	Black Texture
	Bronze
	Graphite Grey
	Chrome door trim
	Brushed door trim

Control Options:	Remote
Fuel Options:	Logs
	Pebbles
	Driftwood

Flue Type

Class 1:	Yes
Class 2:	Yes
Precast Flue:	No
ODS:	Yes

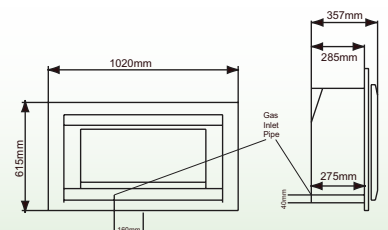
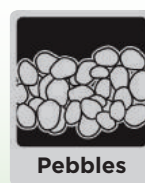

Ideal opening size required:
width 770mm x Height 510mm
x Depth 300mm

Manhattan

Beautifully designed, high efficient glass fronted hole in the wall will enhance any living room. Now available with cream or black interior and we have added Driftwood to the fuel options.



Manhattan with Bronze trim and Black interior



Manhattan with Black trim and Black interior

Fire Info

Gas Input:	2.9kW - 5.5kW
Heat Output:	Up to 4.2kW (High Efficiency)
Finish:	Black Texture
	Bronze
	Graphite Grey
	Chrome door trim
	Brushed door trim

Control Options:	Remote
Fuel Options:	Logs
	Pebbles
	Driftwood

Flue Type

Class 1:	Yes
Class 2:	Yes
Precast Flue:	No
ODS:	Yes

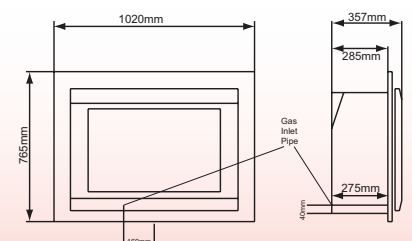
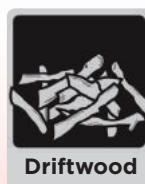

Ideal opening size required:
width 770mm x Height 660mm
x Depth 300mm

Gem (Shown with Lisa Surround)

One of the most outstanding, realistic and hottest open fronted fires on the market giving a massive 4.2kW of heat. Available with chrome or black inner sides.

(ask your retailer for details)



Gem with Contemporary Grace trim



Gem with Monarch trim



Gem with Contemporary trim

Fire Info

Gas Input:	4.1kW - 6.9kW
Heat Output:	Up to 4.2kW
Finish:	Chrome
	Brass
	Black
	Contemporary
	Majestic

Control Options: Manual, Slide, Remote Touch

Fuel Options: Coals
Pebbles
* LPG version temporarily unavailable

Flue Type

Class 1:	Yes
Class 2:	Yes
Precast Flue:	No
ODS:	Yes

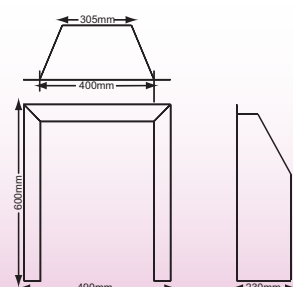

Gem



Gem with Chrome trim and inner sides with Grace fret

Option Range

This is a range cleverly consisting of five interchangeable facias. All the pictures of the Option range in this brochure are shown with the Gem open fronted High Output gas fire; however you now also have the choice of our Montana glass fronted High Efficiency fire. Choosing the Option trim with the Montana fire could save you up to 35% gas, takes the efficiency to 81% and adds an extra fuel option of logs.



Option Range also available with Montana High Efficiency Fire

Electric version now available please ask your retailer for details

Fire Info

Gas Input: Gem	4.1kW - 6.9kW
Gas Input: Montana	2.6kW - 5.2kW
Heat Output:	Up to 4.2kW
Finish:	Chrome, Brushed, Graphite, Copper, Black
Option 2 & 4 NOW Available with Brass Trim	

Control Options:	Manual, Remote
Fuel Options:	Coals, Pebbles, Campfire (<i>Montana only</i>)

Flue Type	
Class 1:	Yes
Class 2:	Yes
Precast Flue:	No
ODS:	Yes

Option 1
Depth Gem: 230mm
Montana: 270mm

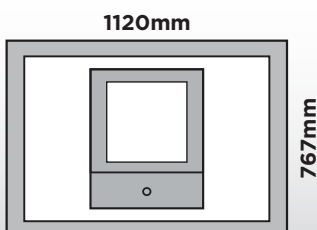

Option 2,3,4,5
Depth Gem: 230mm
Montana: 270mm

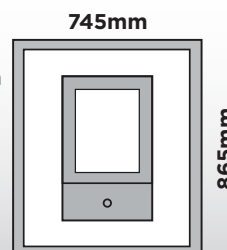

Opening sizes required

415mm wide x 570mm high
Depth 250mm with Gem Fire
320mm with Montana

Option Range

Option 1



Option 1 shown with the Gem open fronted gas fire



Option 5



Coals

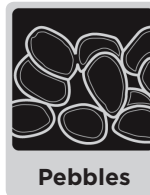

Pebbles



Campfire Logs

Option 3



Options with Montana fire upto 81% efficient and additional option of campfire logs.

Option Range

Option 4



Option 4 shown with the Gem Open Fronted Gas Fire, also available with Brass Trim.



Royale (3 & 4 Sided)

The Royale, shown here with the Montana glass fronted gas fire, is now available with the open Gem fire. Both versions are capable of an impressive 4.2KW of heat, however choosing the Montana Royale can save you up in running costs and also adds Logs to the fuel options.

Royale also available with Gem Fire



3 Sided Royale shown with the Montana Glass Fronted Gas Fire

3 Sided Gem Royale

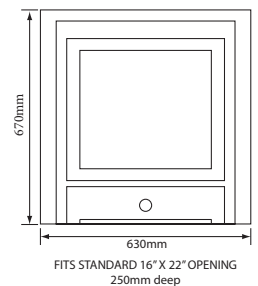

Depth required with Montana is 320mm

4 Sided Gem Royale

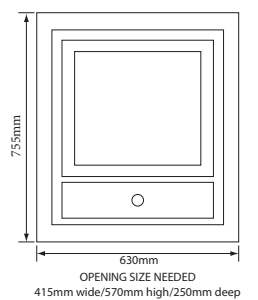

Depth required with Montana is 320mm

Fire Info

Gas Input: Gem	4.1kW - 6.9kW
Gas Input: Montana	2.6kW - 5.2kW
Heat Output:	Up to 4.2kW
Finish:	Chrome, Brushed, Graphite, Copper Black
	NOW Available with Brass Trim

Control Options: Manual or Remote

Fuel Options: Coals
Pebbles
Logs (*Montana only*)

Flue Type

Class 1:	Yes
Class 2:	Yes
Precast Flue:	No
ODS:	Yes

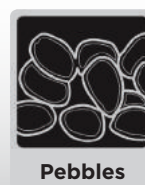

Royale with Montana fire 81% efficient and additional option of campfire logs.

Royale

4 Sided Royale shown with the Gem open fronted gas fire



4 Sided Royale in black

Montana HE (Glass Fronted)

The Montana high efficiency fire is a superb looking deep bed, glass fronted living flame gas fire which convects up to 4.2kw of heat into your room and can save you up to 35% in running costs compared to an open fronted fire. You have a choice of trim finishes and we have now added Logs to the fuel options.



Montana in Chrome with Pebbles



Montana in Brass with Coals



Montana in Brass with Logs

Fire Info

Gas Input:	2.6kW - 5.6kW
Heat Output:	Up to 4.5kW (High Efficiency)
Finish:	Chrome
	Brass
	Black
	Contemporary
	Majestic

Control Options:	Manual, Remote
Fuel Options:	Coals
	Pebbles
	Logs

Flue Type

Class 1:	Yes
Class 2:	Yes
Precast Flue:	No
ODS:	Yes

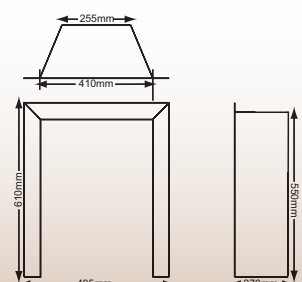
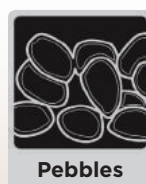

HE CLASS 1 EFFICIENT

Montana

HE CLASS **1** EFFICIENT



Montana H.E. in Chrome with the Grace Fret



Grace

Contemporary Trim shown with Gem fire

Grace Contemporary Trim

Finishing Options:	Chrome
	Brushed
	Black
	Bronze
	Graphite
	Star Graphite
	Star Black
Available With:	Montana
	Gem
	Super Radiant
	Slimline Radiant
	Diamond

Monarch Trim

Finishing Options:	Satin Finish
	Black
	Bronze
	Graphite
	Star Graphite
	Star Black
Available With:	Montana
	Gem
	Super Radiant
	Slimline Radiant
	(Manual or remote control fires only)

Monarch Trim



Monarch trim and front with Gem inset gas fire

The Monarch and Contemporary trims are our own designs and are exclusive to the Crystal Fires range of living flame fires.



Super Radiant & Slimline Radiant

The only difference between the Super Radiant and Slimline Radiant fires is the depth. Both fires have the same trim options & can produce an impressive 3.9kw, creating a vibrant red fuel bed glow and a fantastic looking flame effect.

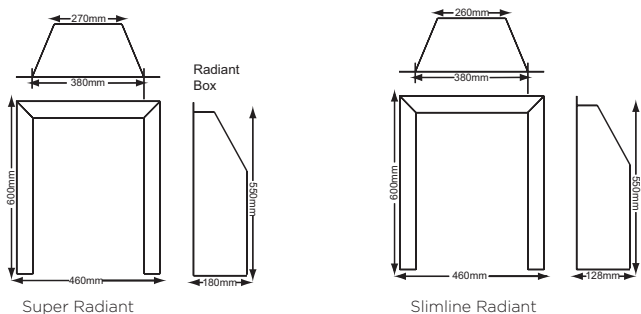

Gas Input:	4.1kW - 6.5kW
Heat Output:	Up to 3.9kW
Finish:	Chrome
	Brass
	Contemporary
	Black
Control Options:	Manual control
	Remote control
	Touch control
	Slide control
Fuel Options:	Coals
	Pebbles
	Campfire Logs

Flue Type	
Class 1:	Yes
Class 2:	Yes
Precast Flue:	Yes
ODS:	Yes



Slimline with contemporary trim and pebbles



Super with Brass trim and grace fret

Diamond

Even though the Diamond fire is designed for shallow or Pre-cast Flues and is only 100mm deep, it still produces up to 3.9kw of heat, making it one of the hottest fires of its type on the market.

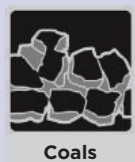
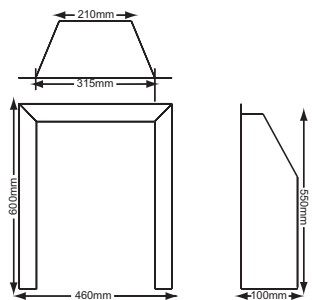

Gas Input:	4.1kW - 6.5kW
Heat Output:	Up to 3.9kW
Finish:	Chrome
	Brass
	Contemporary
	Majestic
	Black
Control Options:	Manual, Remote
Fuel Options:	Coals
	Pebbles

Flue Type	
Class 1:	Yes
Class 2:	Yes
Precast Flue:	Yes
ODS:	Yes



Diamond with contemporary trim and Coals



Diamond with Chrome trim and tiffany fret



Super Radiant
& Slimline Radiant
Super Radiant with Chrome Trim & Grace Fret



Diamond
Diamond with Brass Trim, Coals & Antique Blenheim Fret

Lisa Surround

(with Gem Fire)

The Lisa surround, shown here with the Gem fire, is a wall mounted fire surround that can incorporate any of our 16" gas fires. Also shown below is its little sister the Laura which is the fully inset version without the outer trim. Available in a choice of finishes, ask your retailer for details.

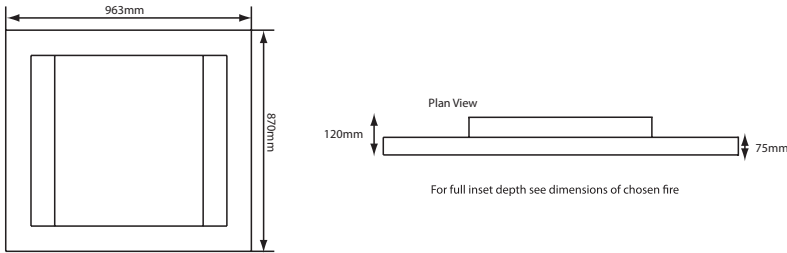

Gas Input:	4.1kW - 6.9kW
Heat Output:	Up to 4.2kW
Finish:	Chrome trim Brass trim Brushed trim Black trim
Control Options:	Manual Remote
Fuel Options:	Coals Pebbles
Flue Type	
Class 1:	Yes
Class 2:	Yes
Precast Flue:	No
ODS:	Yes



Lisa surround with Brass trim



Laura with Chrome trim

Emerald

(with Gem Fire)

This inset hole in the wall fire is beautifully designed and benefits from the immense heat of our gem fire. Also shown below is the Emerald Scoop which is the same specification, just an alternative facia. Please ask your retailer for details.

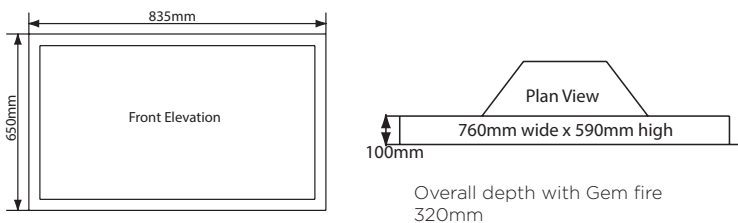

Gas Input:	4.1kW - 6.9kW
Heat Output:	Up to 4.2kW
Trim Finish:	Brushed trim Chrome trim Black trim
Control Options:	Manual Remote
Fuel Options:	Coals Pebbles
Flue Type	
Class 1:	Yes
Class 2:	Yes
Precast Flue:	No
ODS:	Yes



Emerald scoop in Chrome with Gem fire



Lisa Surround

Lisa Surround with chrome trim, shown with Gem fire



Emerald

with Gem fire & chrome trim

6



Montana

THE CLASS **1** EFFICIENT

1

Montana with chrome and coals

2

Montana with chrome and logs

3

3 Sided Royale with brass and pebbles

4

Montana with brass and pebbles

5

3 Sided Royale with chrome and coals

6

3 Sided Royale with chrome and logs



Crystal Electric Fires



Calera

Calera Electric fire with Brass Trim



Calera with Chrome Contemporary Grace trim



Calera Royale 3 Sided in Chrome



Calera Option 4 in Black and Chrome
(Pictured fully inset, can also be wall hung)



Calera with Monarch fascia

Electric Fire Info

An Impressive range of electric fires with a very realistic flame effect using LED lighting.

Heat Output: 1 or 2 kW

Trim Options:

Calera Chrome, Black, Brass, Brushed Monarch, Contemporary Grace Royale 3 or 4 Sided, Option **Range**

Calera Elite (Inlayed Trim) Black & Brass, Black & Chrome, Chrome & Brushed, Brass & Satin

Control Options: Manual

Fuel Options: Comes with both Coals & Pebbles

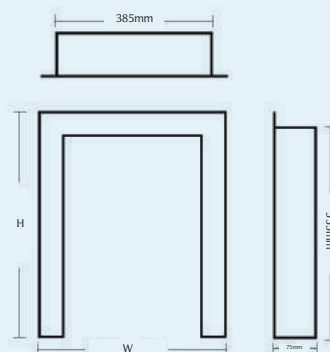

Standard and inlayed trim 610mm High x 490mm Wide
Contemporary Grace trim 610 High x 500mm Wide
Monarch fascia 610mm High x 520mm Wide

Any images may not be copied or reproduced without our permission.



This fire Gives you a higher heat output than your average fire.



Crystal Fires 5 year Guarantee subject to terms and conditions. see www.crystalfires.co.uk for full T&C's

Approved Company



REG No. 517 567



“Support your Local Retailer”

Due to the specialist nature of our fires, we strongly recommend you support your local retailer to receive the best technical advice, installation requirements and after sales service.



Manufactured in Great Britain

All products are manufactured in a UK based factory to CE standard.



1 Valentines Building, Aintree Racecourse Business Park,
Aintree, Liverpool L9 5AY
Telephone: 0151 521 3222 • Fax: 0151 521 1222 • Web: www.crystalfires.co.uk

EVERY CARE HAS BEEN TAKEN TO ENSURE THE INFORMATION IN THIS BROCHURE IS CORRECT, BUT SHOULD BE USED AS A GUIDE ONLY. SLIGHT CHANGES OR IMPROVEMENTS MAYBE MADE, PLEASE CHECK WITH YOUR RETAILER BEFORE PURCHASE.

ALL DIMENSIONS ARE SUBJECT TO MANUFACTURING TOLERANCES.